

PART NUMBER	DESCRIPTION
CCR-33M	Commercial Latching SPDT, DC-3GHz
CR-33M	Elite Latching SPDT, DC-3GHz

The CCR-33M/CR-33M is a broadband, SPDT, electromechanical, coaxial switch designed to switch a microwave signal from a common input to either of two outputs. The characteristic impedance is 75 Ohms. The small switches incorporate mini-SMB connectors. The CCR-33M/CR-33M series switch is offered with a latching actuator. This design is compatible with the two most common mounting hole patterns. The CCR-33M/CR-33M series switch is interchangeable with a variety of switches.



ENVIRONMENTAL AND PHYSICAL CHARACTERISTICS	
Operating Temperature	
Commercial Model, CCR-33M	-40°C to 65°C
Elite Model, CR-33M	-55°C to 85°C
Vibration (MIL-STD-202 Method 214, Condition D, non-operating)	10 g's RMS
Shock (MIL-STD-202 Method 213, Condition D, non-operating)	500 g's
Standard Actuator Life	5,000,000 cycles
Actuator Life w/ Additional Features	1,000,000 cycles
Connector Type	mini-SMB
Humidity (Moisture Seal)	Available
Weight	1.65 oz. (46.78g) (max.)

ELECTRICAL CHARACTERISTICS	
Form Factor	SPDT, break before make
Frequency Range	
CCR-33M	DC-3 GHz
CR-33M	DC-3 GHz
Characteristic Impedance	75 Ohms
Operate Time	10 ms (max.)
Actuation Voltage Available	12 15 24 28 V
Actuation Current, max. @ ambient	140 170 90 65 mA

TYPICAL PERFORMANCE CHARACTERISTICS			
Frequency	DC-1 GHz	1-2 GHz	2-3 GHz
Insertion Loss, dB, typical.	0.1	0.2	0.2
Isolation, dB, typical.	70	65	65
VSWR, typical.	1.1:1	1.3:1	1.3:1

For maximum limits, please see charts on page 3-5

PART NUMBERING SYSTEM

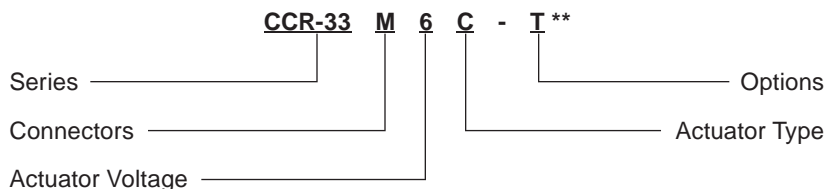

Connector
M: mini-SMB Female

Actuator Voltage
6: 28 Vdc Latching
7: 15 Vdc Latching
8: 12 Vdc Latching
9: 24 Vdc Latching

Actuator Type
0: Standard Contacts
C: Indicator Contacts
D: Self Cutoff Only
E: Indicators and Self Cutoff

Options
T: TTL Drivers with Diodes
D: Transient Suppression Diodes
R: Positive + Common
N: Narrow Body
M: Moisture Seal
S: 9 Pin D-Sub Connector

**SEE PARTS LIST ON PAGES 7-8

For other options, contact factory.

Series CCR-33M/CR-33M

Miniature DC-3 GHz
Latching SPDT Coaxial Switch



SCHEMATICS AND MECHANICAL OUTLINE

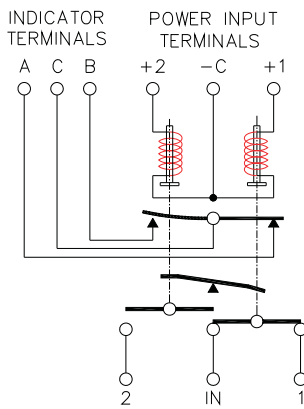

Indicators

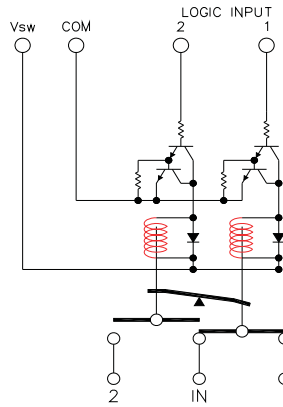

TTL

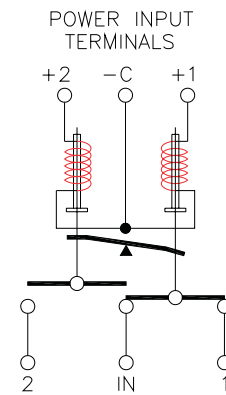

Analog

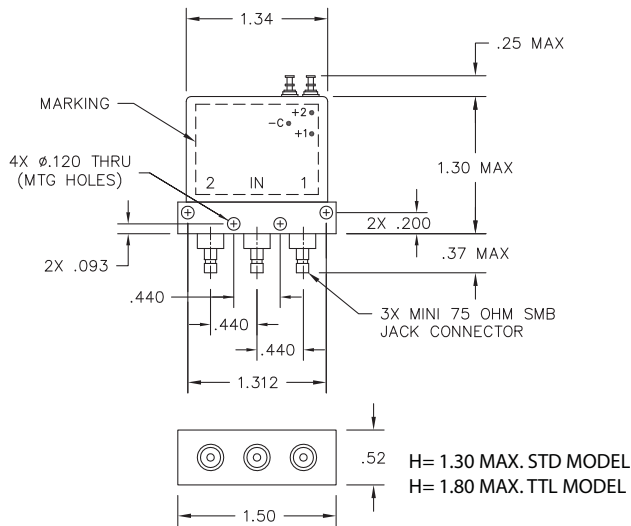
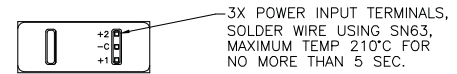
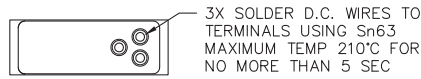

Standard Width Body

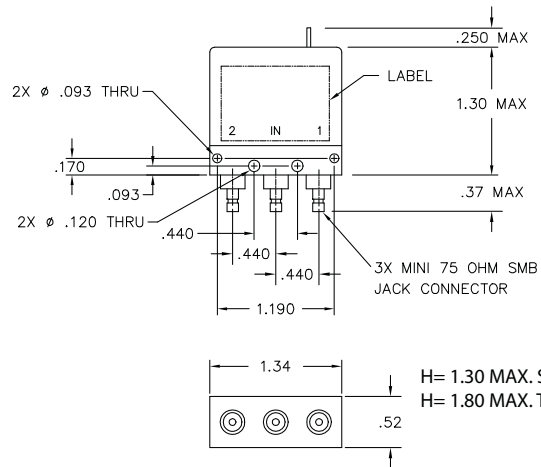

Optional Narrow Width Body

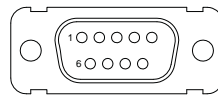

"-S OPTION" 9-PIN D-SUB CONNECTOR (EXAMPLE: CCR-33M60-S)

9 PIN D-SUB PINOUT FOR LATCHING SPDT				
Pin No.	OPTIONS			
	Basic	Indicators	TTL	Indicators & TTL
1	1	1		
2	2	2		
3	C	C	Common	Common
4			1	1
5			2	2
6			Vsw	Vsw
7		A		A
8		B		B
9		C		C

TRUTH TABLE (with TTL option)					
Logic Input		RF Path		Indicator (if applicable)	
1	2	IN to 1	IN to 2	A	B
0	0	No Change			
1	0	On	Off	C	0
0	1	Off	On	0	C
1	1	Forbidden			

TYPICAL NARROWBAND RF INSERTION LOSS PERFORMANCE CURVES

Insertion Loss (DC-1 GHz)

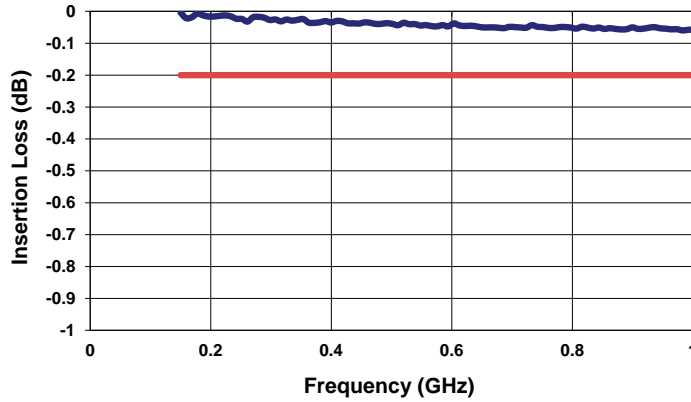

Insertion Loss (1-2 GHz)

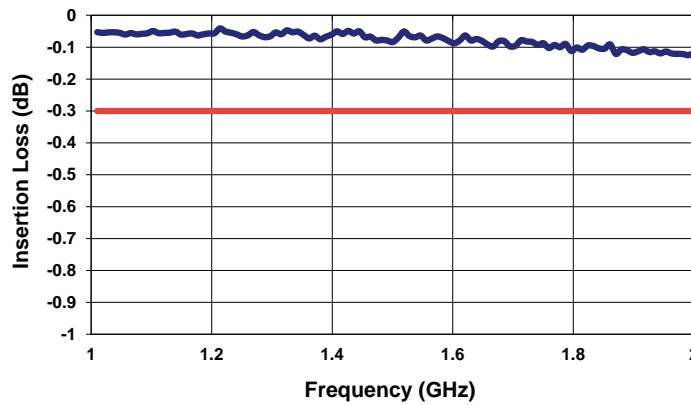

Insertion Loss (2-3 GHz)

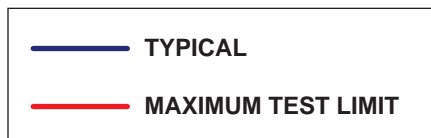
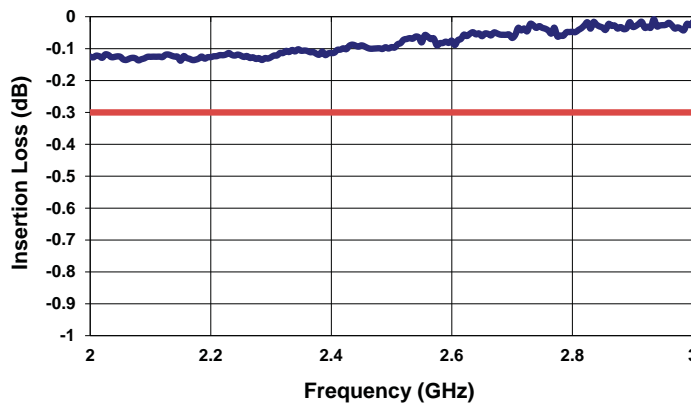

TYPICAL NARROWBAND RF ISOLATION PERFORMANCE CURVES

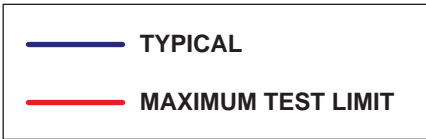
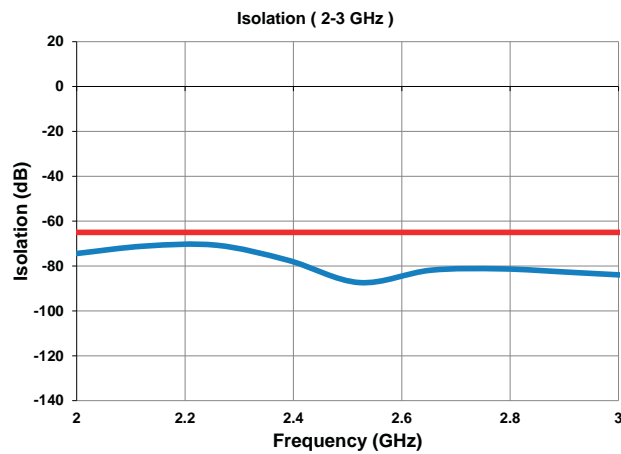
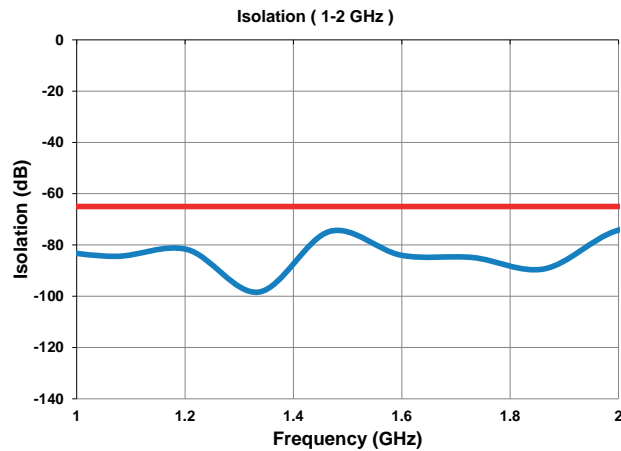
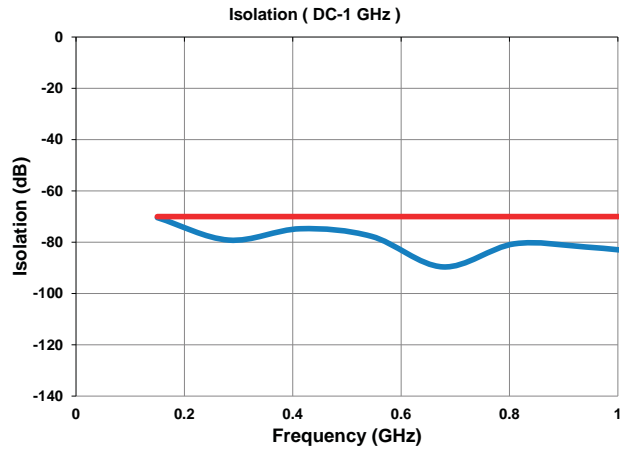

TYPICAL NARROWBAND RF VSWR PERFORMANCE CURVES

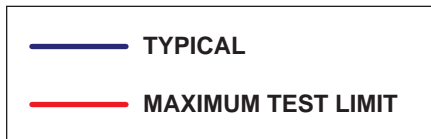
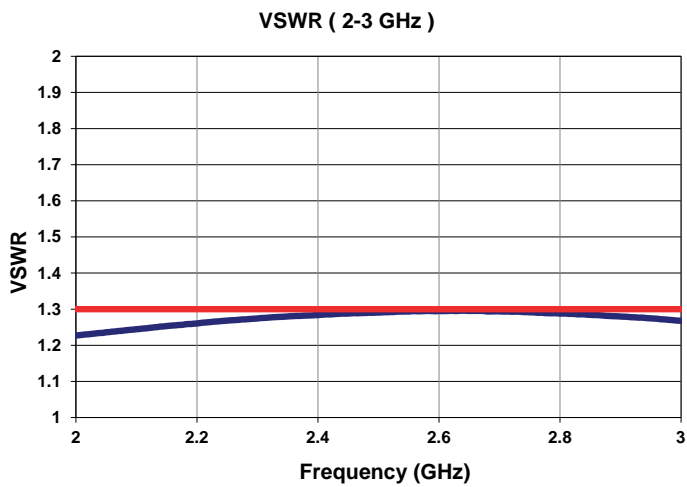
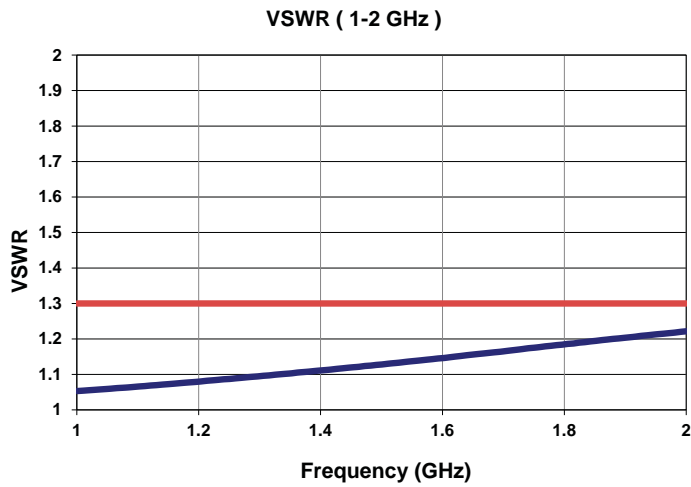
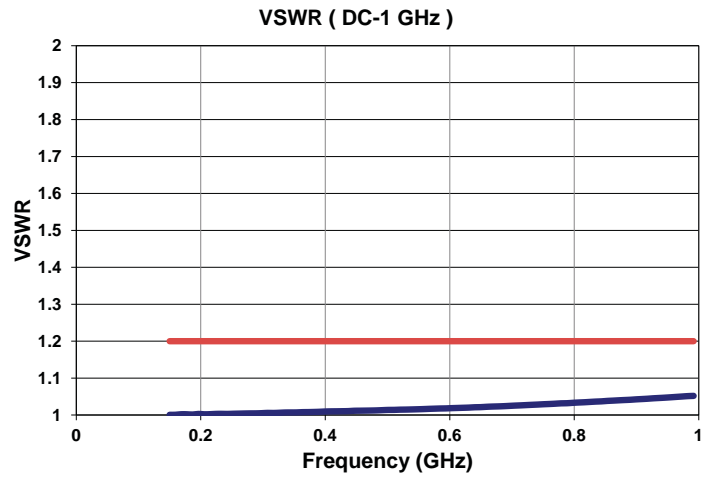

Series CCR-33M/CR-33M

Miniature DC–3 GHz

Latching SPDT Coaxial Switch



TELEDYNE
COAX SWITCHES
Everywhereyoulook™

GLOSSARY

Actuator

An actuator is the electromechanical mechanism that transfers the RF contacts from one position to another upon DC command.

Arc Suppression Diode

A diode is connected in parallel with the coil. This diode limits the “reverse EMF spike” generated when the coil de-energizes to 0.7 volts. The diode cathode is connected to the positive side of the coil and the anode is connected to the negative side.

Date Code

All switches are marked with either a unique serial number or a date code. Date codes are in accordance with MIL-STD-1285 Paragraph 5.2.5 and consist of four digits. The first two digits define the year and the last two digits define the week of the year (YYWW). Thus, 1032 identifies switches that passed through final inspection during the 32nd week of 2010.

Latching

A latching switch remains in the selected position whether or not voltage is maintained. This can be accomplished with either a magnetic or mechanical latching mechanism.

Indicator

Indicators tell the system which position the switch is in. Other names for indicators are telemetry contacts or tellback circuit. Indicators are usually a set of internally mounted DC contacts linked to the actuator. They can be wired to digital input lines, status lights, or interlocks. Unless otherwise specified, the maximum indicator contact rating is 30 Vdc, 50 mA, or 1.5 Watts into a resistive load.

Isolation

Isolation is the measure of the power level at the output connector of an unconnected RF channel as referenced to the power at the input connector. It is specified in dB below the input power level.

Self-Cutoff

The self-cutoff option disables the actuator current on completion of actuation. Either a series contact (linked to the actuator) or an IC driver circuit provides the current cutoff. This option results in minimum power consumption by the RF switch. Cutthroat is another name used in the industry for this option. Pulse latching is a term used to describe a switch without this feature.

SPDT Switch

A single-pole double-throw, bi-directional switch that can be used as having one input and two outputs or two inputs and one output.

Switching Time

Switching time is the total interval beginning with the arrival of the leading edge of the command pulse at the switch DC input and ending with the completion of the switch transfer,

including contact bounce. It consists of three parts: (1) inductive delay in the coil, (2) transfer time of the physical movement of the contacts, and (3) the bounce time of the RF contacts.

TTL Switch Driver Option

As a special option, switch drivers can be provided for both failsafe and latching switches, which are compatible with industry-standard low-power Schottky TTL circuits.

Performance Parameters vs Frequency

Generally speaking, the RF performance of coaxial switches is frequency dependent. With increasing frequency, VSWR and insertion loss increase while isolation decreases. All data sheets specify these three parameters as “worst case” at the highest operating frequency. If the switch is to be used over a narrow frequency band, better performance can be achieved.

Actuator Current vs Temperature

The resistance of the actuator coil varies as a function of temperature. There is an inverse relationship between the operating temperature of the switch and the actuator drive current. For switches operating at 28 VDC, the approximate actuator drive current at temperature, T, can be calculated using the equation:

$$I_T = \frac{I_A}{[1 + .00385 (T-20)]}$$

Where:

I_T = Actuator current at temperature, T

I_A = Room temperature actuator current – see data sheet

T = Temperature of interest in °C

Magnetic Sensitivity

An electro-mechanical switch can be sensitive to ferrous materials and external magnetic fields. Neighboring ferrous materials should be permitted no closer than 0.5 inches and adjacent external magnetic fields should be limited to a flux density of less than 5 Gauss.

SPECIAL FEATURE

Switching High-Power or Highly Sensitive Signals

Ensure the most linear response with the best galvanically matched contact system in the industry. Extremely low passive intermodulation is standard on all of our switches.

Carrier Frequency 1	Carrier Frequency 2	PIM 3rd Order Frequency	PIM 5th Order Frequency
870 MHz	893 MHz	847 MHz	824 MHz

	3rd Order Intermodulation	5th Order Intermodulation
SPDT	–91 dBm	–110 dBm
	–134 dBc	–153 dBc

LATCHING CCR-33M/CR-33M PART NUMBER LIST

	PART No.		PART No.		PART No.
1	CCR-33MXC	43	CCR-33MXD-N	85	CCR-33MXE-TNM
2	CCR-33MXC-D	44	CCR-33MXD-N	86	CCR-33MXE-TNMS
3	CCR-33MXC-DM	45	CCR-33MXD-NM	87	CCR-33MXE-TNS
4	CCR-33MXC-DMS	46	CCR-33MXD-NMS	88	CCR-33MX0
5	CCR-33MXC-DN	47	CCR-33MXD-NS	89	CCR-33MX0-D
6	CCR-33MXC-DNM	48	CCR-33MXD-R	90	CCR-33MX0-DM
7	CCR-33MXC-DNMS	49	CCR-33MXD-RM	91	CCR-33MX0-DMS
8	CCR-33MXC-DNS	50	CCR-33MXD-RMS	92	CCR-33MX0-DN
9	CCR-33MXC-DR	51	CCR-33MXD-RN	93	CCR-33MX0-DNM
10	CCR-33MXC-DRM	52	CCR-33MXD-RNM	94	CCR-33MX0-DNMS
11	CCR-33MXC-DRMS	53	CCR-33MXD-RNMS	95	CCR-33MX0-DNS
12	CCR-33MXC-DRN	54	CCR-33MXD-RNS	96	CCR-33MX0-DR
13	CCR-33MXC-DRNMS	55	CCR-33MXD-RS	97	CCR-33MX0-DRM
14	CCR-33MXC-DRNS	56	CCR-33MXD-S	98	CCR-33MX0-DRMS
15	CCR-33MXC-DRS	57	CCR-33MXD-T	99	CCR-33MX0-DRN
16	CCR-33MXC-DS	58	CCR-33MXD-TM	100	CCR-33MX0-DRNMS
17	CCR-33MXC-M	59	CCR-33MXD-TMS	101	CCR-33MX0-DRNS
18	CCR-33MXC-MS	60	CCR-33MXD-TN	102	CCR-33MX0-DRS
19	CCR-33MXC-N	61	CCR-33MXD-TNM	103	CCR-33MX0-DS
20	CCR-33MXC-NM	62	CCR-33MXD-TNMS	104	CCR-33MX0-M
21	CCR-33MXC-NMS	63	CCR-33MXD-TNS	105	CCR-33MX0-MS
22	CCR-33MXC-NS	64	CCR-33MXE	106	CCR-33MX0-N
23	CCR-33MXC-R	65	CCR-33MXE-M	107	CCR-33MX0-NM
24	CCR-33MXC-RM	66	CCR-33MXE-MS	108	CCR-33MX0-NMS
25	CCR-33MXC-RMS	67	CCR-33MXE-N	109	CCR-33MX0-NS
26	CCR-33MXC-RN	68	CCR-33MXE-N	110	CCR-33MX0-R
27	CCR-33MXC-RNM	69	CCR-33MXE-NM	111	CCR-33MX0-RM
28	CCR-33MXC-RNMS	70	CCR-33MXE-NMS	112	CCR-33MX0-RMS
29	CCR-33MXC-RNS	71	CCR-33MXE-NS	113	CCR-33MX0-RN
30	CCR-33MXC-RS	72	CCR-33MXE-R	114	CCR-33MX0-RNM
31	CCR-33MXC-S	73	CCR-33MXE-RM	115	CCR-33MX0-RNMS
32	CCR-33MXC-T	74	CCR-33MXE-RMS	116	CCR-33MX0-RNS
33	CCR-33MXC-TM	75	CCR-33MXE-RN	117	CCR-33MX0-RS
34	CCR-33MXC-TMS	76	CCR-33MXE-RNM	118	CCR-33MX0-S
35	CCR-33MXC-TN	77	CCR-33MXE-RNMS	119	CCR-33MX0-T
36	CCR-33MXC-TNM	78	CCR-33MXE-RNS	120	CCR-33MX0-TM
37	CCR-33MXC-TNMS	79	CCR-33MXE-RS	121	CCR-33MX0-TMS
38	CCR-33MXC-TNS	80	CCR-33MXE-S	122	CCR-33MX0-TN
39	CCR-33MXC-TS	81	CCR-33MXE-T	123	CCR-33MX0-TNM
40	CCR-33MXD	82	CCR-33MXE-TM	124	CCR-33MX0-TNMS
41	CCR-33MXD-M	83	CCR-33MXE-TMS	125	CCR-33MX0-TNS
42	CCR-33MXD-MS	84	CCR-33MXE-TN	126	CCR-33MX0-TS

* X = 6 (28Vdc), 7 (15Vdc), 8 (12Vdc) and 9 (24Vdc)