

PART NUMBER	DESCRIPTION
CCR-39S	Commercial Latching Multi-throw, DC-18GHz
CR-39S	Elite Latching Multi-throw, DC-22GHz

The CCR-39S/CR-39S is a broadband, multi-throw, electromechanical coaxial switch designed to switch a microwave signal from a common input to any of 3, 4, 5, or 6 outputs. The characteristic impedance is 50 Ohms. The switches are small using the popular connector spacing on a 1.062" dia. circle. Each position has an individual actuator mechanism allowing random position selection. This also minimizes switching time.

The CCR-39S/CR-39S comes with a latching actuator. The latching switch remains in the last position selected when the switch is de-energized. STD dual command requires a reset pulse before a new selected position. A separate reset circuit allows all positions to be set to an open position. User must provide both reset (clear) and set (select new position) commands.



Available with
USB & Ethernet
Control!



Click here
MMC SERIES

ENVIRONMENTAL AND PHYSICAL CHARACTERISTICS	
Operating Temperature	
Commercial Model, CCR-39S	-40°C to 65°C
Elite Model, CR-39S	-55°C to 85°C
Vibration (MIL-STD-202 Method 214, Condition D, non-operating)	10 g's RMS
Shock (MIL-STD-202 Method 213, Condition D, non-operating)	500 g's
Standard Actuator Life	5,000,000 cycles
Actuator Life w/ Additional Features	1,000,000 cycles
Connector Type	SMA
Humidity (Moisture Seal)	Available
Weight	6 oz. (170.1g) (max.)

ELECTRICAL CHARACTERISTICS	
Form Factor	Multi-Throw, break before make
Frequency Range	
CCR-39S	DC-18 GHz
CR-39S	DC-22 GHz
Characteristic Impedance	50 Ohms
Operate Time	20 ms (max.)
Actuation Voltage Available	12 15 24 28 V
Actuation Current	255 205 130 90 mA
Reset Current (# of Positions)	3 765 615 390 270 mA
	4 1020 820 520 360 mA
	5 1275 1025 650 450 mA
	6 1530 1230 780 540 mA

TYPICAL PERFORMANCE CHARACTERISTICS						
Frequency	DC-4 GHz	4-8 GHz	8-12 GHz	12-16 GHz	16-20 GHz	20-22 GHz
Insertion Loss, dB, typ.	0.1	0.2	0.2	0.3	0.3	0.4
Isolation, dB, typ.	80	80	80	80	75	70
VSWR, typ.	1.05:1	1.1:1	1.2:1	1.2:1	1.2:1	1.2:1

For maximum limits, please see charts on pages 6-8

PART NUMBERING SYSTEM

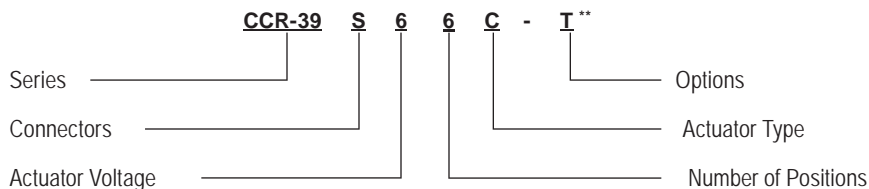

CONNECTOR	ACTUATOR VOLTAGE	NUMBER OF POSITIONS	ACTUATOR TYPE	OPTIONS
S: SMA FEMALE	6: 28 VDC LATCHING	3: SP3T	0: NO INDICATOR CONTACTS	T: TTL DRIVERS WITH DIODES
	7: 15 VDC LATCHING	4: SP4T	C: INDICATOR CONTACTS	D: COIL TRANSIENT SUPPRESSION DIODES
	8: 12 VDC LATCHING	5: SP5T	D: SELF CUTOFF ONLY	R: POSITIVE + COMMON
	9: 24 VDC LATCHING	6: SP6T		TD: DECODERS AND TTL DRIVERS WITH DIODES
				M: MOISTURE SEAL
				S: D-SUB CONNECTOR*

** SEE PARTS LIST ON PAGE 11-13

For additional options, please contact factory.

* D-Sub Connector may be 9 or 15 pin depending on number of throws. (See Connector Pinout page)

Series CCR-39S/CR-39S

Multi-Throw DC-18 GHz/DC-22 GHz
Latching Coaxial Switch



SCHEMATICS AND MECHANICAL OUTLINE

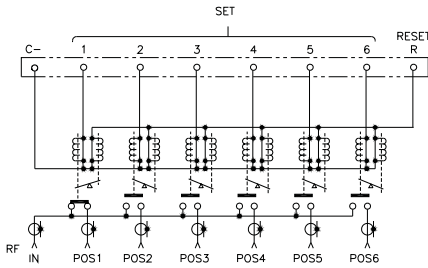

Analog

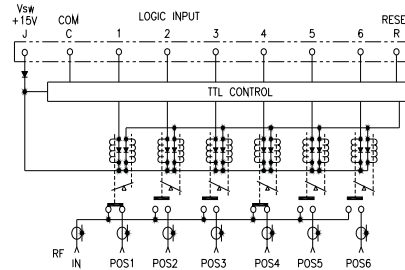

TTL

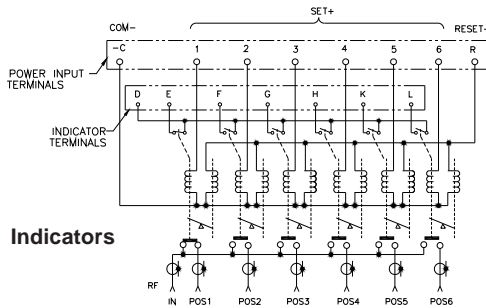

Indicators

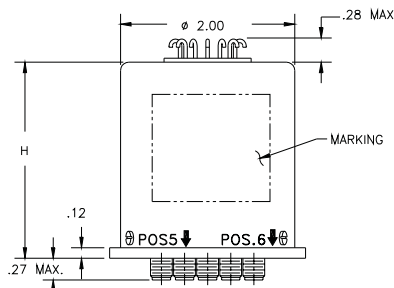
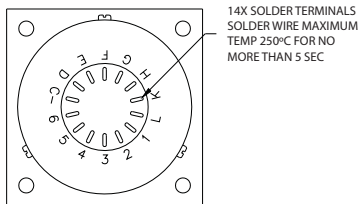

H = 2.25 STD & Indicator Model
H = 2.50 All OTHER Models

SP3T

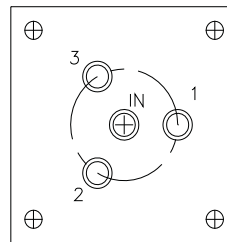

SP5T

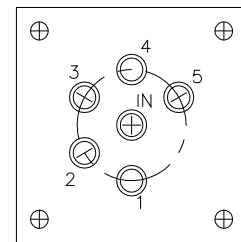

SP6T

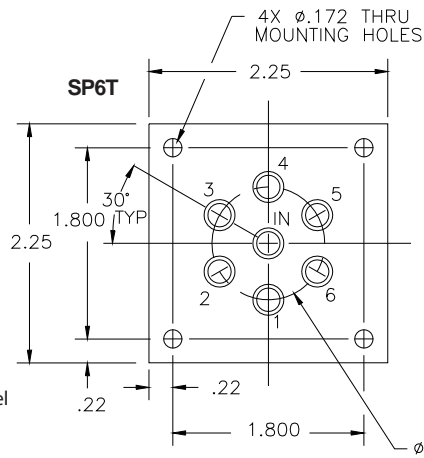

SP4T

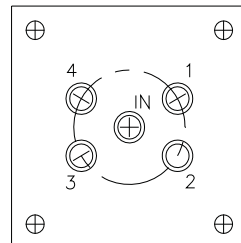

“-S OPTION” 9-PIN D-SUB OR 15-PIN D-MICRO CONNECTOR (EXAMPLE: CCR-39S660-S)

CONNECTOR PINOUT FOR LATCHING SP3T MULTI-THROW SWITCHES						
EXAMPLE	CR-39S130-S	CR-39S13C-S	CR-39S130-TS	CR-39S13C-TS	CR-39S130-TDS	CR-39S13C-TDS
PIN NO	2706650 9-PINS	2707572 15-PINS	2706650 9-PINS	2707572 15-PINS	2706650 9-PINS	2707572 15-PINS
INDICATOR		YES		YES		YES
TTL			YES	YES		
DECODERS & TTL					YES	YES
1	PORT 1	PORT 1	TTL 1	TTL 1	LOGIC 1	LOGIC 1
2	PORT 2	PORT 3	TTL 2	TTL 2	LOGIC 2	LOGIC 2
3	PORT 3	PORT 3	TTL 3	TTL 3	LOGIC 3	LOGIC 3
4						
5						
6						
7	COMMON	COMMON	COMMON	COMMON	COMMON	COMMON
8	RESET	RESET	RESET	RESET		
9		Vsw	Vsw	Vsw	Vsw	Vsw
10		D INDICATOR (COM)		D INDICATOR (COM)		D INDICATOR (COM)
11		E INDICATOR		E INDICATOR		E INDICATOR
12		F INDICATOR		F INDICATOR		F INDICATOR
13		G INDICATOR		G INDICATOR		G INDICATOR
14						
15						

CONNECTOR PINOUT FOR LATCHING SP4T MULTI-THROW SWITCHES						
EXAMPLE	CR-39S140-S	CR-39S14C-S	CR-39S140-TS	CR-39S14C-TS	CR-39S140-TDS	CR-39S14C-TDS
PIN NO	2706650 9-PINS	2707572 15-PINS	2706650 9-PINS	2707572 15-PINS	2706650 9-PINS	2707572 15-PINS
INDICATOR		YES		YES		YES
TTL			YES	YES		
DECODERS & TTL					YES	YES
1	PORT 1	PORT 1	TTL 1	TTL 1	LOGIC 1	LOGIC 1
2	PORT 2	PORT 3	TTL 2	TTL 2	LOGIC 2	LOGIC 2
3	PORT 3	PORT 3	TTL 3	TTL 3	LOGIC 3	LOGIC 3
4	PORT 4	PORT 4	TTL 4	TTL 4		
5						
6						
7	COMMON	COMMON	COMMON	COMMON	COMMON	COMMON
8	RESET	RESET	RESET	RESET		
9			Vsw	Vsw	Vsw	Vsw
10		D INDICATOR (COM)		D INDICATOR (COM)		D INDICATOR (COM)
11		E INDICATOR		E INDICATOR		E INDICATOR
12		F INDICATOR		F INDICATOR		F INDICATOR
13		G INDICATOR		G INDICATOR		G INDICATOR
14		H INDICATOR		H INDICATOR		H INDICATOR
15						

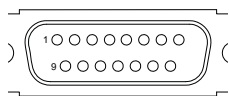

9-PIN D-SUB CONNECTOR

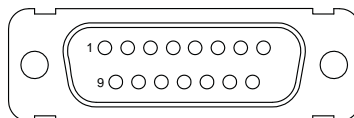

15-PIN D-SUB CONNECTOR

Series CCR-39S/CR-39S
Multi-Throw DC-18 GHz/DC-22 GHz
Latching Coaxial Switch



CONNECTOR PINOUT FOR LATCHING SP5T MULTI-THROW SWITCHES						
EXAMPLE	CR-39S150-S	CR-39S15C-S	CR-39S150-TS	CR-39S15C-TS	CR-39S150-TDS	CR-39S15C-TDS
PIN NO	2706650 9-PINS	2707572 15-PINS	2706650 9-PINS	2707572 15-PINS	2706650 9-PINS	2707572 15-PINS
INDICATOR		YES		YES		YES
TTL			YES	YES		
DECODERS & TTL					YES	YES
1	PORT 1	PORT 1	TTL 1	TTL 1	LOGIC 1	LOGIC 1
2	PORT 2	PORT 3	TTL 2	TTL 2	LOGIC 2	LOGIC 2
3	PORT 3	PORT 3	TTL 3	TTL 3	LOGIC 3	LOGIC 3
4	PORT 4	PORT 4	TTL 4	TTL 4		
5	PORT 5	PORT 5	TTL 5	TTL 5		
6						
7	COMMON	COMMON	COMMON	COMMON	COMMON	COMMON
8	RESET	RESET	RESET	RESET		
9			Vsw	Vsw	Vsw	Vsw
10		D INDICATOR (COM)		D INDICATOR (COM)		D INDICATOR (COM)
11		E INDICATOR		E INDICATOR		E INDICATOR
12		F INDICATOR		F INDICATOR		F INDICATOR
13		G INDICATOR		G INDICATOR		G INDICATOR
14		H INDICATOR		H INDICATOR		H INDICATOR
15		K INDICATOR		K INDICATOR		K INDICATOR

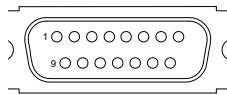

9-PIN D-SUB CONNECTOR

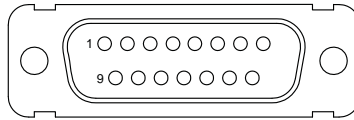

15-PIN D-SUB CONNECTOR

CONNECTOR PINOUT FOR LATCHING SP6T MULTI-THROW SWITCHES						
EXAMPLE	CR-39S160-S	CR-39S16C-S	CR-39S160-TS	CR-39S16C-TS	CR-39S160-TDS	CR-39S16C-TDS
PIN NO	2706650 9-PINS	2707572 15-PINS	2706650 9-PINS	C00-166-1 26-PINS	2706650 9-PINS	2707572 15-PINS
INDICATOR		YES		YES		YES
TTL			YES	YES		
DECODERS & TTL					YES	YES
1	PORT 1	PORT 1	TTL 1	TTL 1	LOGIC 1	LOGIC 1
2	PORT 2	PORT 3	TTL 2	TTL 2	LOGIC 2	LOGIC 2
3	PORT 3	PORT 3	TTL 3	TTL 3	LOGIC 3	LOGIC 3
4	PORT 4	PORT 4	TTL 4	TTL 4		
5	PORT 5	PORT 5	TTL 5	TTL 5		
6	PORT 6	PORT 6	TTL 6	TTL 6		
7	COMMON	COMMON	COMMON	COMMON	COMMON	COMMON
8	RESET	RESET	RESET	RESET		
9		D INDICATOR (COM)	Vsw	Vsw	Vsw	D INDICATOR (COM)
10		E INDICATOR				E INDICATOR
11		F INDICATOR				F INDICATOR
12		G INDICATOR				G INDICATOR
13		H INDICATOR				H INDICATOR
14		K INDICATOR				K INDICATOR
15		L INDICATOR		D INDICATOR (COM)		L INDICATOR
16				E INDICATOR		
17				F INDICATOR		
18				G INDICATOR		
19				H INDICATOR		
20				K INDICATOR		
21				L INDICATOR		
22						
23						
24						
25						
26						

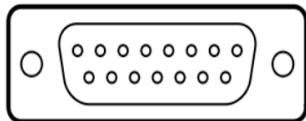

15-PIN D-SUB CONNECTOR

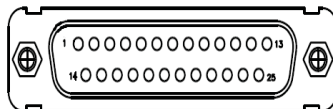

25-PIN D-SUB CONNECTOR

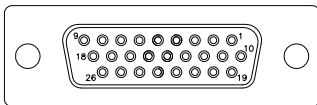

26-PIN D-SUB CONNECTOR

Series CCR-39S/CR-39S
Multi-Throw DC-18 GHz/DC-22 GHz
Latching Coaxial Switch



TRUTH TABLE Latching
CCR-39SX3C-T

Logic Input				RF Path				Indicator Switches		
1	2	3	R	J1	J2	J3	Reset	E	F	G
1	0	0	0	On	Off	Off	Off	C	0	0
0	1	0	0	Off	On	Off	Off	0	C	0
0	0	1	0	Off	Off	On	Off	0	0	C

TRUTH TABLE Latching
CCR-39SX3C-TD

Logic Input			RF Path				Indicator Switches		
1	2	3	J1	J2	J3	Reset	E	F	G
0	0	0	On	Off	Off	Off	C	0	0
1	0	0	Off	On	Off	Off	0	C	0
0	1	0	Off	Off	On	Off	0	0	C
0	1	1	Off	Off	Off	Reset	0	0	0
1	1	1	COIL OFF				0	0	0

TRUTH TABLE Latching
CCR-39SX4C-T

Logic Input					RF Path					Indicator Switches			
1	2	3	4	R	J1	J2	J3	J4	Reset	E	F	G	H
1	0	0	0	0	On	Off	Off	Off	Off	C	0	0	0
0	1	0	0	0	Off	On	Off	Off	Off	0	C	0	0
0	0	1	0	0	Off	Off	On	Off	Off	0	0	C	0
0	0	0	1	0	Off	Off	Off	On	Off	0	0	0	C

TRUTH TABLE Latching
CCR-39SX4C-TD

Logic Input			RF Path					Indicator Switches			
1	2	3	J1	J2	J3	J4	Reset	E	F	G	H
0	0	0	On	Off	Off	Off	Off	C	0	0	0
1	0	0	Off	On	Off	Off	Off	0	C	0	0
0	1	0	Off	Off	On	Off	Off	0	0	C	0
1	1	0	Off	Off	Off	On	Off	0	0	0	C
0	1	1	Off	Off	Off	Off	Reset	0	0	0	0
1	1	1	COIL OFF					0	0	0	0

TRUTH TABLE Latching
CCR-39S5C-T

Logic Input						RF Path						Indicator Switches				
1	2	3	4	5	R	J1	J2	J3	J4	J5	Reset	E	F	G	H	K
1	0	0	0	0	0	On	Off	Off	Off	Off	Off	C	0	0	0	0
0	1	0	0	0	0	Off	On	Off	Off	Off	Off	0	C	0	0	0
0	0	1	0	0	0	Off	Off	On	Off	Off	Off	0	0	C	0	0
0	0	0	1	0	0	Off	Off	Off	On	Off	Off	0	0	0	C	0
0	0	0	0	1	0	Off	Off	Off	Off	On	Off	0	0	0	0	C

TRUTH TABLE Latching
CCR-39S5C-TD

Logic Input			RF Path					Indicator Switches									
1	2	3	J1	J2	J3	J4	J5	Reset	E	F	G	H	K				
0	0	0	On	Off	Off	Off	Off	Off	C	0	0	0	0				
1	0	0	Off	On	Off	Off	Off	Off	0	C	0	0	0				
0	1	0	Off	Off	On	Off	Off	Off	0	0	C	0	0				
1	1	0	Off	Off	Off	On	Off	Off	0	0	0	C	0				
0	0	1	Off	Off	Off	Off	On	Off	0	0	0	0	C				
0	1	1	Off	Off	Off	Off	Off	Reset	0	0	0	0	0				
1	1	1	COIL OFF										0	0	0	0	0

TRUTH TABLE Latching
CCR-39S6C-T

Logic Input							RF Path						Indicator Switches						
1	2	3	4	5	6	R	J1	J2	J3	J4	J5	J6	Reset	E	F	G	H	K	L
1	0	0	0	0	0	0	On	Off	Off	Off	Off	Off	Off	C	0	0	0	0	0
0	1	0	0	0	0	0	Off	On	Off	Off	Off	Off	Off	0	C	0	0	0	0
0	0	1	0	0	0	0	Off	Off	On	Off	Off	Off	Off	0	0	C	0	0	0
0	0	0	1	0	0	0	Off	Off	Off	On	Off	Off	Off	0	0	0	C	0	0
0	0	0	0	1	0	0	Off	Off	Off	Off	On	Off	Off	0	0	0	0	C	0
0	0	0	0	0	1	0	Off	Off	Off	Off	Off	On	Off	0	0	0	0	0	C

TRUTH TABLE Latching
CCR-39S6C-TD

Logic Input			RF Path						Indicator Switches											
1	2	3	J1	J2	J3	J4	J5	J6	Reset	E	F	G	H	K	L					
0	0	0	On	Off	Off	Off	Off	Off	Off	C	0	0	0	0	0					
1	0	0	Off	On	Off	Off	Off	Off	Off	0	C	0	0	0	0					
0	1	0	Off	Off	On	Off	Off	Off	Off	0	0	C	0	0	0					
1	1	0	Off	Off	Off	On	Off	Off	Off	0	0	0	C	0	0					
0	0	1	Off	Off	Off	Off	On	Off	Off	0	0	0	0	C	0					
1	0	1	Off	Off	Off	Off	Off	On	Off	0	0	0	0	0	C					
0	1	1	Off	Off	Off	Off	Off	Off	Reset	0	0	0	0	0	0					
1	1	1	COIL OFF												0	0	0	0	0	0

TYPICAL NARROWBAND RF INSERTION LOSS PERFORMANCE CURVES

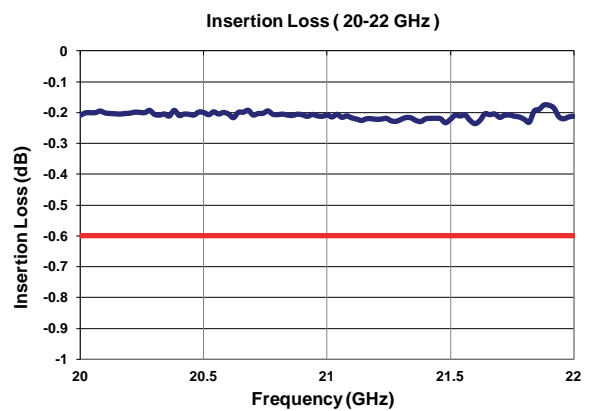
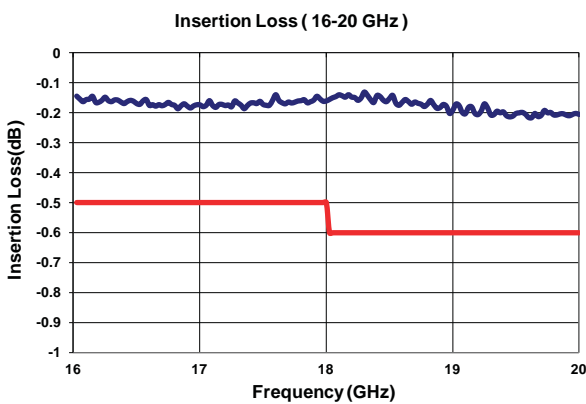
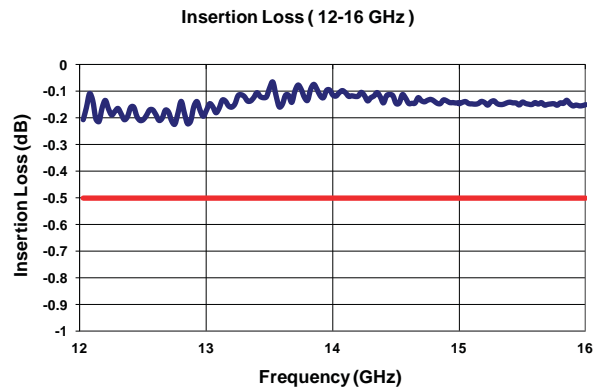
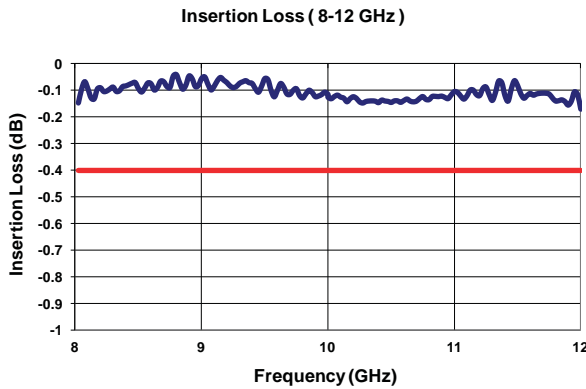
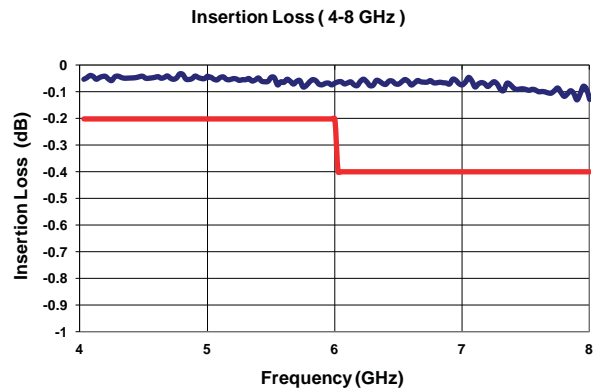
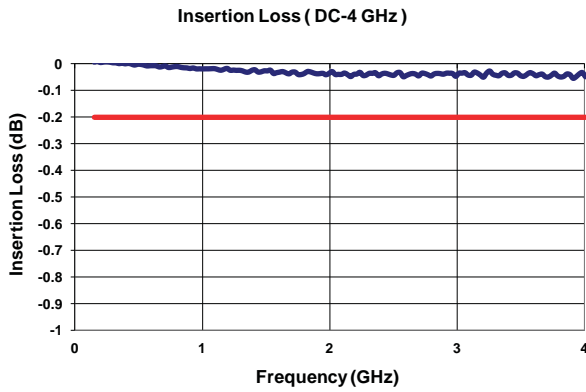

18GHz+ ELITE MODEL ONLY

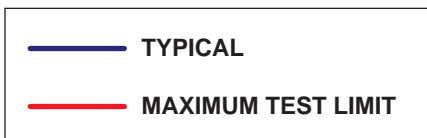

TYPICAL NARROWBAND RF ISOLATION PERFORMANCE CURVES

Isolation (DC-4 GHz)

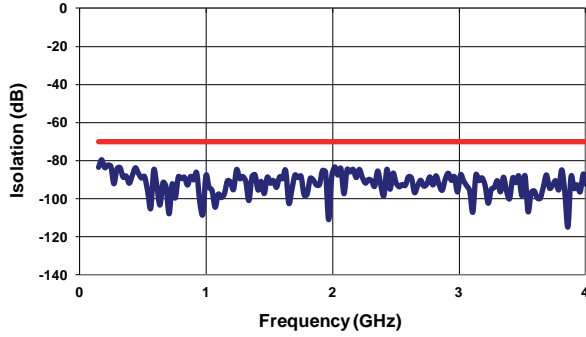

Isolation (4-8 GHz)

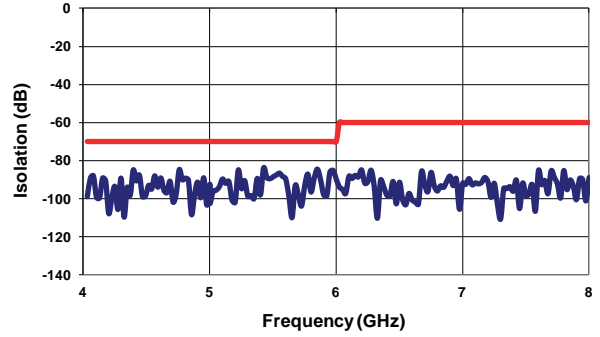

Isolation (8-12 GHz)

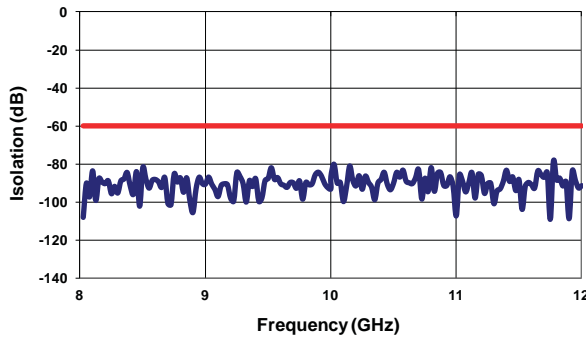

Isolation (12-16 GHz)

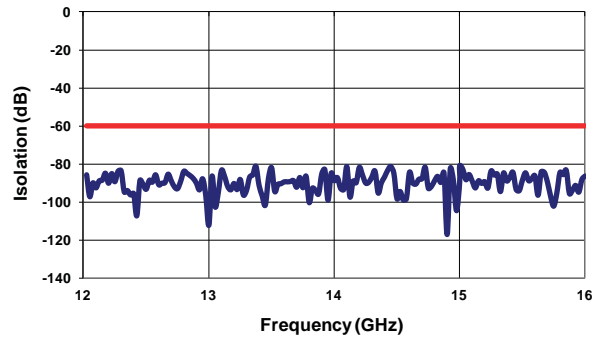

Isolation (16-20 GHz)

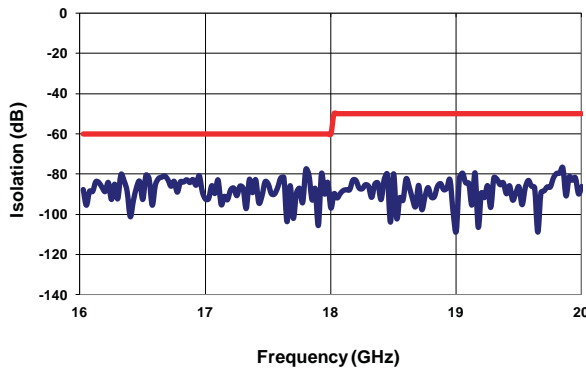

Isolation (20-22 GHz)

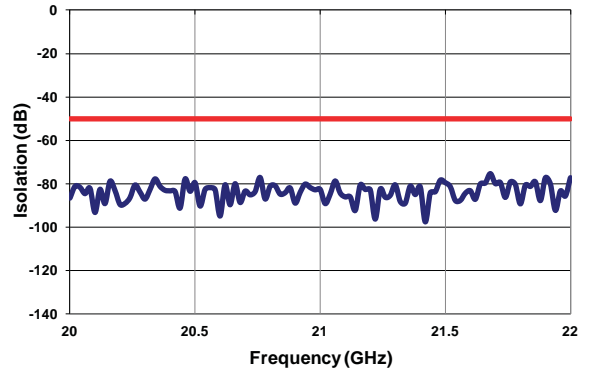

18GHz+ ELITE MODEL ONLY

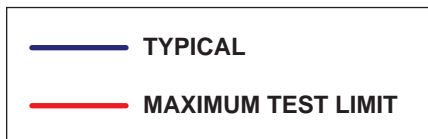

TYPICAL NARROWBAND RF VSWR PERFORMANCE CURVES

VSWR (DC-4 GHz)

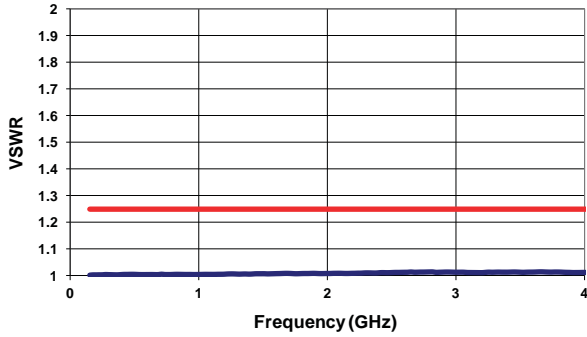

VSWR (4-8 GHz)

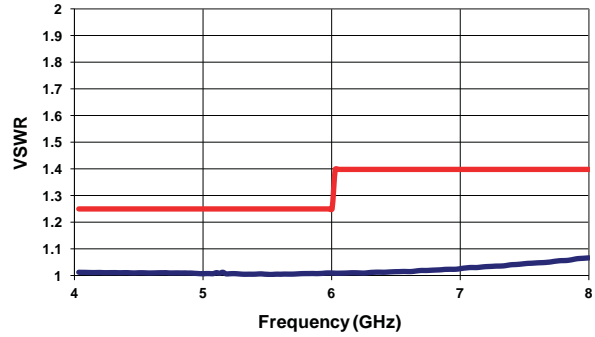

VSWR (8-12 GHz)

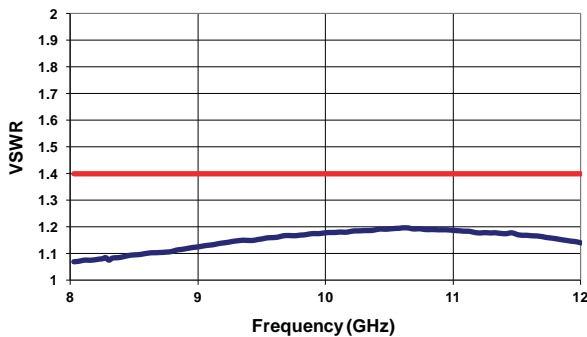

VSWR (12-16 GHz)

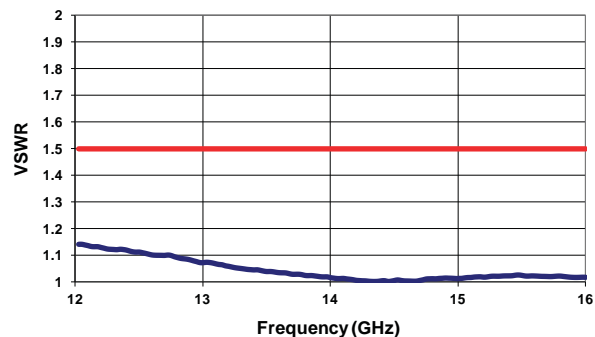

VSWR (16-20 GHz)

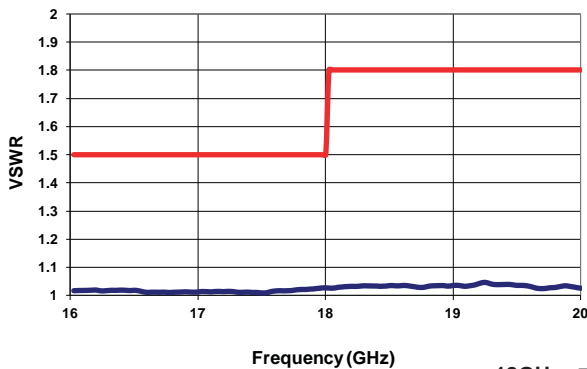

VSWR (20-22 GHz)

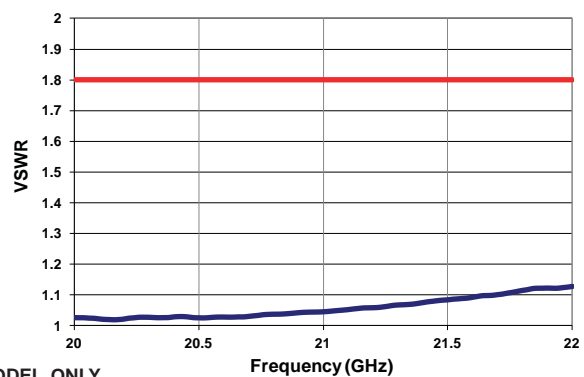

18GHz+ ELITE MODEL ONLY

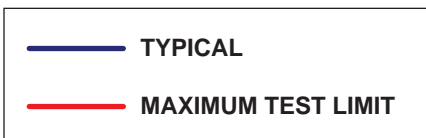

TYPICAL POWER PERFORMANCE CURVE

Power Handling vs. Frequency

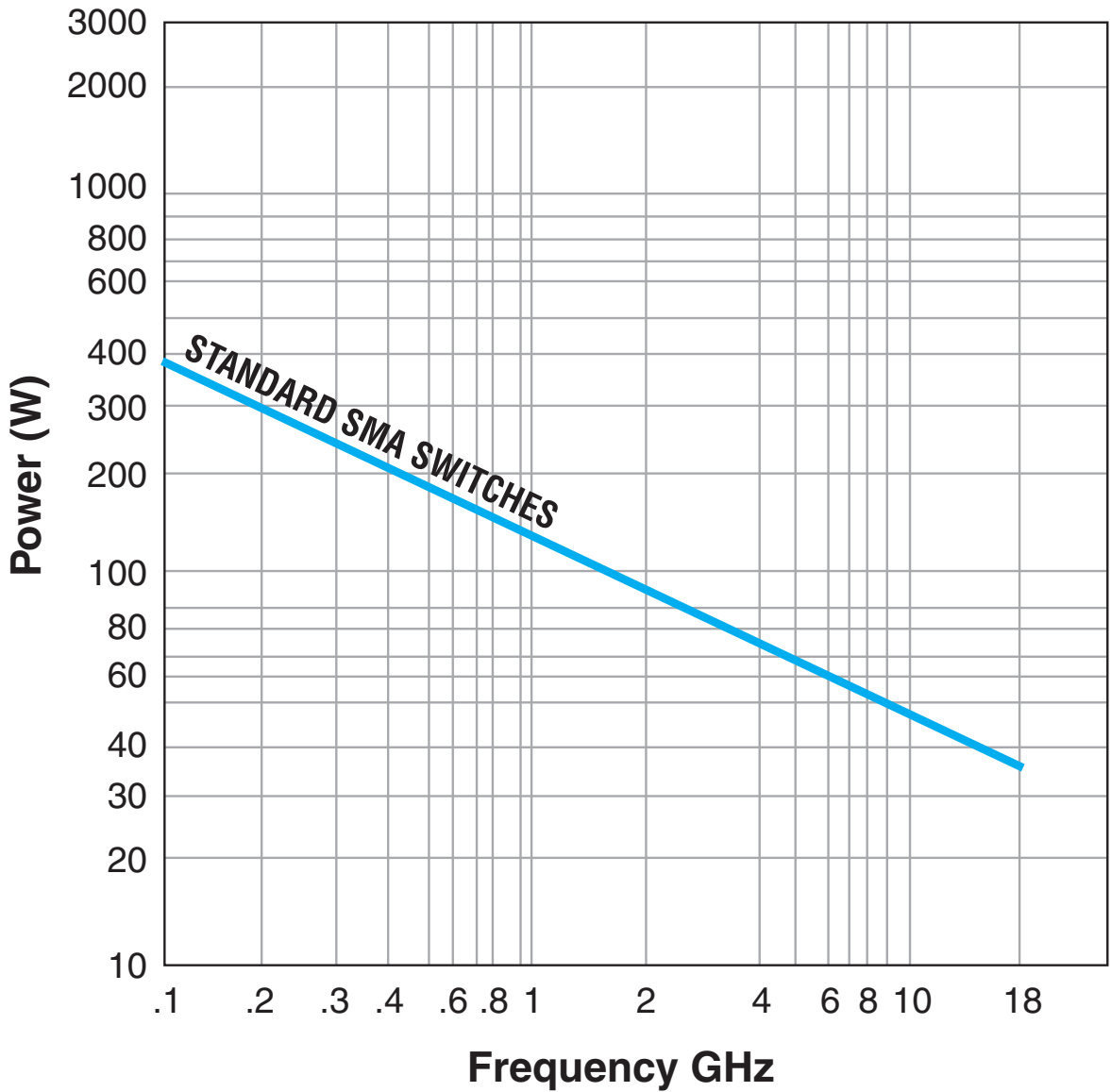

Estimates based on the following reference conditions:

- Ambient temperature of 40°C or less
- Sea level operation
- Load VSWR of 1.20:1 maximum
- No high-power (hot) switching

Please contact Teledyne Coax Switches for derating factors when applications do not meet the foregoing reference conditions.

GLOSSARY

Actuator

An actuator is the electromechanical mechanism that transfers the RF contacts from one position to another upon DC command.

Arc Suppression Diode

A diode is connected in parallel with the coil. This diode limits the "reverse EMF spike" generated when the coil de-energizes to 0.7 volts. The diode cathode is connected to the positive side of the coil and the anode is connected to the negative side.

Date Code

All switches are marked with either a unique serial number or a date code. Date codes are in accordance with MIL-STD-1285 Paragraph 5.2.5 and consist of four digits. The first two digits define the year and the last two digits define the week of the year (YYWW). Thus, 1032 identifies switches that passed through final inspection during the 32nd week of 2010.

Indicator

Indicators tell the system which position the switch is in. Other names for indicators are telemetry contacts or tellback circuit. Indicators are usually a set of internally mounted DC contacts linked to the actuator. They can be wired to digital input lines, status lights, or interlocks. Unless otherwise specified, the maximum indicator contact rating is 30 Vdc, 50 mA, or 1.5 Watts into a resistive load.

Isolation

Isolation is the measure of the power level at the output connector of an unconnected RF channel as referenced to the power at the input connector. It is specified in dB below the input power level.

Multi-Throw Latching Switch

A multi-throw switch is a switch with one input and three or more output ports. The CCR-39 can switch a microwave signal to any of 2,3,4,5 or 6 output from a single common input.

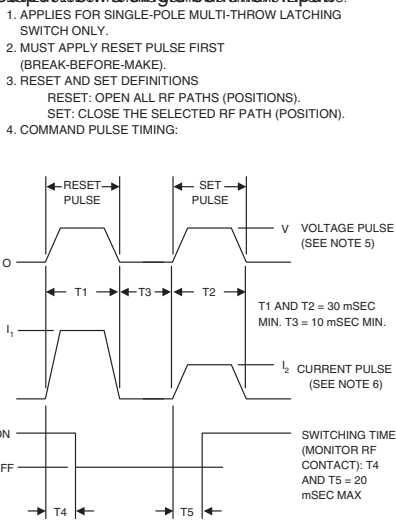

5. COMMAND SWITCHING VOLTAGE:
 V = 26-32 VDC PULSE

6. SWITCHING CURRENT:

SWITCHING CURRENT AT 28 VDC AND 20°C		
NO. OF POS.	RESET (I ₁)	SET (I ₂)
3 POS.	270 mA	90 mA
4 POS.	360 mA	90 mA
5 POS.	450 mA	90 mA
6 POS.	540 mA	90 mA

Switching Time

Switching time is the total interval beginning with the arrival of the leading edge of the command pulse at the switch DC input and ending with the completion of the switch transfer, including contact bounce. It consists of three parts: (1) inductive delay in the coil, (2) transfer time of the physical movement of the contacts, and (3) the bounce time of the RF contacts.

TTL Switch Driver Option

As a special option, switch drivers can be provided for both failsafe and latching switches, which are compatible with industry-standard low-power Schottky TTL circuits.

TD-Option

This option includes a decoder. The 3-bit parallel command is decoded to internally select the appropriate position. See the logic tables. The TD-Option increases the Vsw supply current demand by 50mA max at 28Vdc and +20°C.

Performance Parameters vs Frequency

Generally speaking, the RF performance of coaxial switches is frequency dependent. With increasing frequency, VSWR and insertion loss increase while isolation decreases. All data sheets specify these three parameters as "worst case" at the highest operating frequency. If the switch is to be used over a narrow frequency band, better performance can be achieved.

Actuator Current vs Temperature

The resistance of the actuator coil varies as a function of temperature. There is an inverse relationship between the operating temperature of the switch and the actuator drive current. For switches operating at 28 VDC, the approximate actuator drive current at temperature, T, can be calculated using the equation:

$$I_T = \frac{I_A}{[1 + .00385 (T-20)]}$$

Where:

I_T = Actuator current at temperature, T

I_A = Room temperature actuator current – see data sheet

T = Temperature of interest in °C

Magnetic Sensitivity

An electro-mechanical switch can be sensitive to ferrous materials and external magnetic fields. Neighboring ferrous materials should be permitted no closer than 0.5 inches and adjacent external magnetic fields should be limited to a flux density of less than 5

SPECIAL FEATURE

Switching High-Power or Highly Sensitive Signals

Ensure the most linear response with the best galvanically matched contact system in the industry. Extremely low passive intermodulation is standard on all of our switches.

Carrier Frequency 1	Carrier Frequency 2	PIM 3rd Order Frequency	PIM 5th Order Frequency
870 MHz	893 MHz	847 MHz	824 MHz

	3rd Order Intermodulation	5th Order Intermodulation
Multiple Positions	-96 dBm	-115 dBm
	-139 dBc	-158 dBc

LATCHING CCR-39S/CR-39S PART NUMBER LIST

	PART No.		PART No.		PART No.		PART No.
1	CCR-39SX3C	43	CCR-39SX3O-TMS	85	CCR-39SX4O-DM	127	CCR-39SX5C-DS
2	CCR-39SX3C-D	44	CCR-39SX3O-TS	86	CCR-39SX4O-DR	128	CCR-39SX5C-M
3	CCR-39SX3C-DM	45	CCR-39SX3D	87	CCR-39SX4O-DRM	129	CCR-39SX5C-MS
4	CCR-39SX3C-DR	46	CCR-39SX3D-M	88	CCR-39SX4O-DRS	130	CCR-39SX5C-R
5	CCR-39SX3C-DRM	47	CCR-39SX3D-MS	89	CCR-39SX4O-DS	131	CCR-39SX5C-RM
6	CCR-39SX3C-DRS	48	CCR-39SX3D-R	90	CCR-39SX4O-M	132	CCR-39SX5C-RMS
7	CCR-39SX3C-DS	49	CCR-39SX3D-RM	91	CCR-39SX4O-MS	133	CCR-39SX5C-RS
8	CCR-39SX3C-M	50	CCR-39SX3D-RMS	92	CCR-39SX4O-R	134	CCR-39SX5C-S
9	CCR-39SX3C-MS	51	CCR-39SX3D-RS	93	CCR-39SX4O-RM	135	CCR-39SX5C-T
10	CCR-39SX3C-R	52	CCR-39SX3D-S	94	CCR-39SX4O-RMS	136	CCR-39SX5C-TD
11	CCR-39SX3C-RM	53	CCR-39SX3D-T	95	CCR-39SX4O-RS	137	CCR-39SX5C-TDM
12	CCR-39SX3C-RMS	54	CCR-39SX3D-TD	96	CCR-39SX4O-S	138	CCR-39SX5C-TDMS
13	CCR-39SX3C-RS	55	CCR-39SX3D-TDM	97	CCR-39SX4O-T	139	CCR-39SX5C-TDS
14	CCR-39SX3C-S	56	CCR-39SX3D-TDMS	98	CCR-39SX4O-TD	140	CCR-39SX5C-TM
15	CCR-39SX3C-T	57	CCR-39SX3D-TDS	99	CCR-39SX4O-TDM	141	CCR-39SX5C-TMS
16	CCR-39SX3C-TD	58	CCR-39SX3D-TM	100	CCR-39SX4O-TDMS	142	CCR-39SX5C-TS
17	CCR-39SX3C-TDM	59	CCR-39SX3D-TMS	101	CCR-39SX4O-TDS	143	CCR-39SX5O
18	CCR-39SX3C-TDMS	60	CCR-39SX3D-TS	102	CCR-39SX4O-TM	144	CCR-39SX5O-D
19	CCR-39SX3C-TDS	61	CCR-39SX4C	103	CCR-39SX4O-TMS	145	CCR-39SX5O-DM
20	CCR-39SX3C-TM	62	CCR-39SX4C-D	104	CCR-39SX4O-TS	146	CCR-39SX5O-DR
21	CCR-39SX3C-TMS	63	CCR-39SX4C-DM	105	CCR-39SX4D	147	CCR-39SX5O-DRM
22	CCR-39SX3C-TS	64	CCR-39SX4C-DR	106	CCR-39SX4D-M	148	CCR-39SX5O-DRS
23	CCR-39SX3O	65	CCR-39SX4C-DRM	107	CCR-39SX4D-MS	149	CCR-39SX5O-DS
24	CCR-39SX3O-D	66	CCR-39SX4C-DRS	108	CCR-39SX4D-R	150	CCR-39SX5O-M
25	CCR-39SX3O-DM	67	CCR-39SX4C-DS	109	CCR-39SX4D-RM	151	CCR-39SX5O-MS
26	CCR-39SX3O-DR	68	CCR-39SX4C-M	110	CCR-39SX4D-RMS	152	CCR-39SX5O-R
27	CCR-39SX3O-DRM	69	CCR-39SX4C-MS	111	CCR-39SX4D-RS	153	CCR-39SX5O-RM
28	CCR-39SX3O-DRS	70	CCR-39SX4C-R	112	CCR-39SX4D-S	154	CCR-39SX5O-RMS
29	CCR-39SX3O-DS	71	CCR-39SX4C-RM	113	CCR-39SX4D-T	155	CCR-39SX5O-RS
30	CCR-39SX3O-M	72	CCR-39SX4C-RMS	114	CCR-39SX4D-TD	156	CCR-39SX5O-S
31	CCR-39SX3O-MS	73	CCR-39SX4C-RS	115	CCR-39SX4D-TDM	157	CCR-39SX5O-T
32	CCR-39SX3O-R	74	CCR-39SX4C-S	116	CCR-39SX4D-TDMS	158	CCR-39SX5O-TD
33	CCR-39SX3O-RM	75	CCR-39SX4C-T	117	CCR-39SX4D-TDS	159	CCR-39SX5O-TDM
34	CCR-39SX3O-RMS	76	CCR-39SX4C-TD	118	CCR-39SX4D-TM	160	CCR-39SX5O-TDMS
35	CCR-39SX3O-RS	77	CCR-39SX4C-TDM	119	CCR-39SX4D-TMS	161	CCR-39SX5O-TDS
36	CCR-39SX3O-S	78	CCR-39SX4C-TDMS	120	CCR-39SX4D-TS	162	CCR-39SX5O-TM
37	CCR-39SX3O-T	79	CCR-39SX4C-TDS	121	CCR-39SX5C	163	CCR-39SX5O-TMS
38	CCR-39SX3O-TD	80	CCR-39SX4C-TM	122	CCR-39SX5C-D	164	CCR-39SX5O-TS
39	CCR-39SX3O-TDM	81	CCR-39SX4C-TMS	123	CCR-39SX5C-DM	165	CCR-39SX5D
40	CCR-39SX3O-TDMS	82	CCR-39SX4C-TS	124	CCR-39SX5C-DR	166	CCR-39SX5D-M
41	CCR-39SX3O-TDS	83	CCR-39SX4O	125	CCR-39SX5C-DRM	167	CCR-39SX5D-MS
42	CCR-39SX3O-TM	84	CCR-39SX4O-D	126	CCR-39SX5C-DRS	168	CCR-39SX5D-R

* X = 6 (28Vdc), 7 (15Vdc), 8 (12Vdc) and 9 (24Vdc)

Series CCR-39S/CR-39S
Multi-Throw DC-18 GHz/DC-22 GHz
Latching Coaxial Switch



LATCHING CCR-39S/CR-39S PART NUMBER LIST

	PART No.		PART No.		PART No.		PART No.
169	CCR-39SX5D-RM	211	CCR-39SX6O-MS	253	CR-39SX3C-RS	295	CR-39SX3D-TDM
170	CCR-39SX5D-RMS	212	CCR-39SX6O-R	254	CR-39SX3C-S	296	CR-39SX3D-TDMS
171	CCR-39SX5D-RS	213	CCR-39SX6O-RM	255	CR-39SX3C-T	297	CR-39SX3D-TDS
172	CCR-39SX5D-S	214	CCR-39SX6O-RMS	256	CR-39SX3C-TD	298	CR-39SX3D-TM
173	CCR-39SX5D-T	215	CCR-39SX6O-RS	257	CR-39SX3C-TDM	299	CR-39SX3D-TMS
174	CCR-39SX5D-TD	216	CCR-39SX6O-S	258	CR-39SX3C-TDMS	300	CR-39SX3D-TS
175	CCR-39SX5D-TDM	217	CCR-39SX6O-T	259	CR-39SX3C-TDS	301	CR-39SX4C
176	CCR-39SX5D-TDMS	218	CCR-39SX6O-TD	260	CR-39SX3C-TM	302	CR-39SX4C-D
177	CCR-39SX5D-TDS	219	CCR-39SX6O-TDM	261	CR-39SX3C-TMS	303	CR-39SX4C-DM
178	CCR-39SX5D-TM	220	CCR-39SX6O-TDMS	262	CR-39SX3C-TS	304	CR-39SX4C-DR
179	CCR-39SX5D-TMS	221	CCR-39SX6O-TDS	263	CR-39SX3O	305	CR-39SX4C-DRM
180	CCR-39SX5D-TS	222	CCR-39SX6O-TM	264	CR-39SX3O-D	306	CR-39SX4C-DRS
181	CCR-39SX6C	223	CCR-39SX6O-TMS	265	CR-39SX3O-DM	307	CR-39SX4C-DS
182	CCR-39SX6C-D	224	CCR-39SX6O-TS	266	CR-39SX3O-DR	308	CR-39SX4C-M
183	CCR-39SX6C-DM	225	CCR-39SX6D	267	CR-39SX3O-DRM	309	CR-39SX4C-MS
184	CCR-39SX6C-DR	226	CCR-39SX6D-M	268	CR-39SX3O-DRS	310	CR-39SX4C-R
185	CCR-39SX6C-DRM	227	CCR-39SX6D-MS	269	CR-39SX3O-DS	311	CR-39SX4C-RM
186	CCR-39SX6C-DRS	228	CCR-39SX6D-R	270	CR-39SX3O-M	312	CR-39SX4C-RMS
187	CCR-39SX6C-DS	229	CCR-39SX6D-RM	271	CR-39SX3O-MS	313	CR-39SX4C-RS
188	CCR-39SX6C-M	230	CCR-39SX6D-RMS	272	CR-39SX3O-R	314	CR-39SX4C-S
189	CCR-39SX6C-MS	231	CCR-39SX6D-RS	273	CR-39SX3O-RM	315	CR-39SX4C-T
190	CCR-39SX6C-R	232	CCR-39SX6D-S	274	CR-39SX3O-RMS	316	CR-39SX4C-TD
191	CCR-39SX6C-RM	233	CCR-39SX6D-T	275	CR-39SX3O-RS	317	CR-39SX4C-TDM
192	CCR-39SX6C-RMS	234	CCR-39SX6D-TD	276	CR-39SX3O-S	318	CR-39SX4C-TDMS
193	CCR-39SX6C-RS	235	CCR-39SX6D-TDM	277	CR-39SX3O-T	319	CR-39SX4C-TDS
194	CCR-39SX6C-S	236	CCR-39SX6D-TDMS	278	CR-39SX3O-TD	320	CR-39SX4C-TM
195	CCR-39SX6C-T	237	CCR-39SX6D-TDS	279	CR-39SX3O-TDM	321	CR-39SX4C-TMS
196	CCR-39SX6C-TD	238	CCR-39SX6D-TM	280	CR-39SX3O-TDMS	322	CR-39SX4C-TS
197	CCR-39SX6C-TDM	239	CCR-39SX6D-TMS	281	CR-39SX3O-TDS	323	CR-39SX4O
198	CCR-39SX6C-TDMS	240	CCR-39SX6D-TS	282	CR-39SX3O-TM	324	CR-39SX4O-D
199	CCR-39SX6C-TDS	241	CR-39SX3C	283	CR-39SX3O-TMS	325	CR-39SX4O-DM
200	CCR-39SX6C-TM	242	CR-39SX3C-D	284	CR-39SX3O-TS	326	CR-39SX4O-DR
201	CCR-39SX6C-TMS	243	CR-39SX3C-DM	285	CR-39SX3D	327	CR-39SX4O-DRM
202	CCR-39SX6C-TS	244	CR-39SX3C-DR	286	CR-39SX3D-M	328	CR-39SX4O-DRS
203	CCR-39SX6O	245	CR-39SX3C-DRM	287	CR-39SX3D-MS	329	CR-39SX4O-DS
204	CCR-39SX6O-D	246	CR-39SX3C-DRS	288	CR-39SX3D-R	330	CR-39SX4O-M
205	CCR-39SX6O-DM	247	CR-39SX3C-DS	289	CR-39SX3D-RM	331	CR-39SX4O-MS
206	CCR-39SX6O-DR	248	CR-39SX3C-M	290	CR-39SX3D-RMS	332	CR-39SX4O-R
207	CCR-39SX6O-DRM	249	CR-39SX3C-MS	291	CR-39SX3D-RS	333	CR-39SX4O-RM
208	CCR-39SX6O-DRS	250	CR-39SX3C-R	292	CR-39SX3D-S	334	CR-39SX4O-RMS
209	CCR-39SX6O-DS	251	CR-39SX3C-RM	293	CR-39SX3D-T	335	CR-39SX4O-RS
210	CCR-39SX6O-M	252	CR-39SX3C-RMS	294	CR-39SX3D-TD	336	CR-39SX4O-S

* X = 6 (28Vdc), 7 (15Vdc), 8 (12Vdc) and 9 (24Vdc)

LATCHING CCR-39S/CR-39S PART NUMBER LIST

	PART No.		PART No.		PART No.		PART No.
337	CR-39SX40-T	379	CR-39SX5C-TDS	421	CR-39SX6C	463	CR-39SX6O-TMS
338	CR-39SX40-TD	380	CR-39SX5C-TM	422	CR-39SX6C-D	464	CR-39SX6O-TS
339	CR-39SX40-TDM	381	CR-39SX5C-TMS	423	CR-39SX6C-DM	465	CR-39SX6D
340	CR-39SX40-TDMS	382	CR-39SX5C-TS	424	CR-39SX6C-DR	466	CR-39SX6D-M
341	CR-39SX40-TDS	383	CR-39SX5O	425	CR-39SX6C-DRM	467	CR-39SX6D-MS
342	CR-39SX40-TM	384	CR-39SX5O-D	426	CR-39SX6C-DRS	468	CR-39SX6D-R
343	CR-39SX40-TMS	385	CR-39SX5O-DM	427	CR-39SX6C-DS	469	CR-39SX6D-RM
344	CR-39SX40-TS	386	CR-39SX5O-DR	428	CR-39SX6C-M	470	CR-39SX6D-RMS
345	CR-39SX4D	387	CR-39SX5O-DRM	429	CR-39SX6C-MS	471	CR-39SX6D-RS
346	CR-39SX4D-M	388	CR-39SX5O-DRS	430	CR-39SX6C-R	472	CR-39SX6D-S
347	CR-39SX4D-MS	389	CR-39SX5O-DS	431	CR-39SX6C-RM	473	CR-39SX6D-T
348	CR-39SX4D-R	390	CR-39SX5O-M	432	CR-39SX6C-RMS	474	CR-39SX6D-TD
349	CR-39SX4D-RM	391	CR-39SX5O-MS	433	CR-39SX6C-RS	475	CR-39SX6D-TDM
350	CR-39SX4D-RMS	392	CR-39SX5O-R	434	CR-39SX6C-S	476	CR-39SX6D-TDMS
351	CR-39SX4D-RS	393	CR-39SX5O-RM	435	CR-39SX6C-T	477	CR-39SX6D-TDS
352	CR-39SX4D-S	394	CR-39SX5O-RMS	436	CR-39SX6C-TD	478	CR-39SX6D-TM
353	CR-39SX4D-T	395	CR-39SX5O-RS	437	CR-39SX6C-TDM	479	CR-39SX6D-TMS
354	CR-39SX4D-TD	396	CR-39SX5O-S	438	CR-39SX6C-TDMS	480	CR-39SX6D-TS
355	CR-39SX4D-TDM	397	CR-39SX5O-T	439	CR-39SX6C-TDS		
356	CR-39SX4D-TDMS	398	CR-39SX5O-TD	440	CR-39SX6C-TM		
357	CR-39SX4D-TDS	399	CR-39SX5O-TDM	441	CR-39SX6C-TMS		
358	CR-39SX4D-TM	400	CR-39SX5O-TDMS	442	CR-39SX6C-TS		
359	CR-39SX4D-TMS	401	CR-39SX5O-TDS	443	CR-39SX6O		
360	CR-39SX4D-TS	402	CR-39SX5O-TM	444	CR-39SX6O-D		
361	CR-39SX5C	403	CR-39SX5O-TMS	445	CR-39SX6O-DM		
362	CR-39SX5C-D	404	CR-39SX5O-TS	446	CR-39SX6O-DR		
363	CR-39SX5C-DM	405	CR-39SX5D	447	CR-39SX6O-DRM		
364	CR-39SX5C-DR	406	CR-39SX5D-M	448	CR-39SX6O-DRS		
365	CR-39SX5C-DRM	407	CR-39SX5D-MS	449	CR-39SX6O-DS		
366	CR-39SX5C-DRS	408	CR-39SX5D-R	450	CR-39SX6O-M		
367	CR-39SX5C-DS	409	CR-39SX5D-RM	451	CR-39SX6O-MS		
368	CR-39SX5C-M	410	CR-39SX5D-RMS	452	CR-39SX6O-R		
369	CR-39SX5C-MS	411	CR-39SX5D-RS	453	CR-39SX6O-RM		
370	CR-39SX5C-R	412	CR-39SX5D-S	454	CR-39SX6O-RMS		
371	CR-39SX5C-RM	413	CR-39SX5D-T	455	CR-39SX6O-RS		
372	CR-39SX5C-RMS	414	CR-39SX5D-TD	456	CR-39SX6O-S		
373	CR-39SX5C-RS	415	CR-39SX5D-TDM	457	CR-39SX6O-T		
374	CR-39SX5C-S	416	CR-39SX5D-TDMS	458	CR-39SX6O-TD		
375	CR-39SX5C-T	417	CR-39SX5D-TDS	459	CR-39SX6O-TDM		
376	CR-39SX5C-TD	418	CR-39SX5D-TM	460	CR-39SX6O-TDMS		
377	CR-39SX5C-TDM	419	CR-39SX5D-TMS	461	CR-39SX6O-TDS		
378	CR-39SX5C-TDMS	420	CR-39SX5D-TS	462	CR-39SX6O-TM		

* X = 6 (28Vdc), 7 (15Vdc), 8 (12Vdc) and 9 (24Vdc)