

PART NUMBER	DESCRIPTION
HR255, HR257	Magnetic-Latching, DPDT, Half-Size Crystal Can, Space Grade Relay (HIREL)
<p>Teledyne Relays' HR255/257 Series relay is a High Reliability Off-The Shelf (COTS) relay suitable for demanding space flight applications. When purchased in accordance with Teledyne Relays' standard Hi-Rel Acceptance Test Procedure (ATP) the relays will meet the basic requirements of both the NASA Goddard Space Flight Center's S-311-P-754 Document and the European Space Agency's (ESA) SCC 3601 & 3602 Specifications. The HR255/HR257 Series has become the premier selection for space flight applications requiring low-level switching to dry circuits up to 2 Amp. Teledyne Relays' 50 year history of supplying relays to the spacecraft manufacturing community has supported 95% of all satellite programs worldwide. Relays may be supplied in accordance with the standard requirements of the Hi-Rel ATP or as specified by customer source control drawings. In addition to enhanced test and inspection at the relay level the individual piece parts are inspected to higher standards. Relay leads may be supplied in either gold (Au) or solder dipped finish. All Hi-Rel relays are supplied with full data packages in either hard copy or electronic format. Customer Source Inspection (CSI) may be performed during critical manufacturing and test points.</p>	

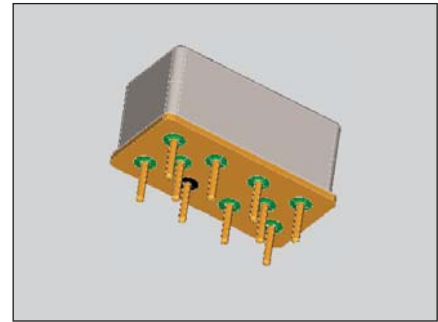

HR255/HR257 HIREL SERIES OVERVIEW
Design Based on QPL-Approved MIL-PRF-39016 Specification
Proven Space Flight Heritage
Meets the general requirements of NASA/GSFC, S311-P-754
Meets the general requirements of ESA/SCC General Specification 3601 & 3602
1x10 ⁻⁸ Leak Rate
Standard Acceptance Test Procedure (ATP) Meets both ESA and NASA Requirements
MIL-DTL-45204 Gold Plating
ANSI-J-STD-006 Requirements for Electric Grade Solder Alloys and Fluxed and Non-Fluxed Sold Solders for Electronic Soldering Applications
100% Small Particle/ Inspection (Millipore Cleaning)

STANDARD HIREL SCREENING (SEE DETAILED SUMMARY OF STANDARD SCREENING ON PAGE 4-9)	
100% Pre-Cap Inspection (Source Inspection Available)	Particle Impact Noise Detection (PIND)
Room Temperature Electrical Measurements	Internal Moisture
Solderability	Thermal Cycle/Miss Test (5,000 cycles total)
Leak/Seal Test (1x10 ⁻⁸)	Room Temperature Electrical Measurements
External Visual & Mechanical	Radiographic Inspection (X-Ray)
Vibration, Sinusoidal (30 G's)	Percent Defect Allowable, failure rate of lot (less than 10%)

ENVIRONMENTAL AND PHYSICAL CHARACTERISTICS			
Form Factor	2 Form C (DPDT)	Operating Temperature	-65°C to +125°C
Frequency Range	DC-3 GHz	Vibration (Sinusoidal)	30 g's 10 to 2500 Hz
Lead Finish	Gold Plated or Solder Coated	Shock (Specific Pulse)	100 g's, 6ms half sine
Hermetic Seal	1 x 10 ⁻⁸ atm-cm ³ /s	Weight	0.46 oz. (13) max.

Series HR255/HR257
 DC up to 3 GHz
 Magnetic Latching Space Grade DPDT Relay



MECHANICAL OUTLINE

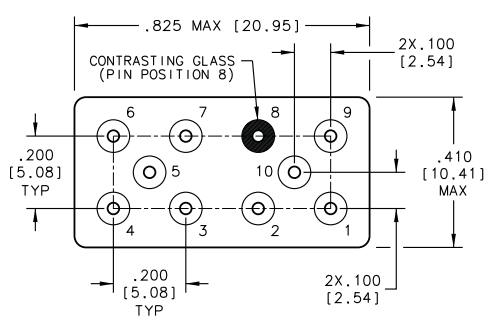
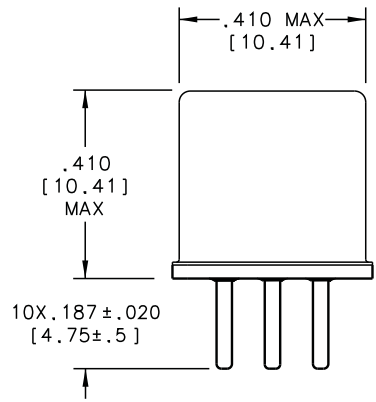
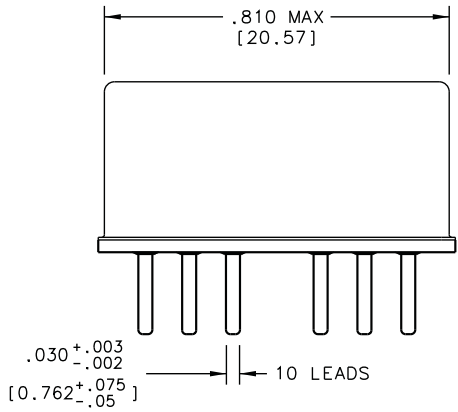

HR257

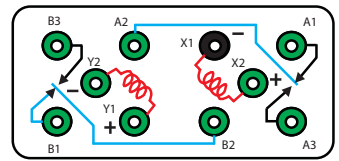

HR255

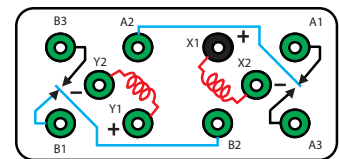

DIMENSIONS ARE IN INCHES, (mm)

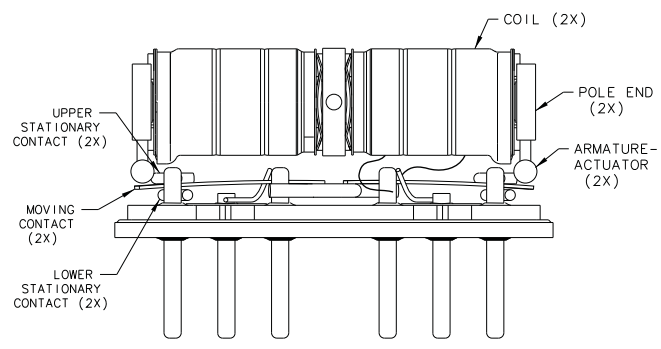

TYPICAL POWER PERFORMANCE CURVE

Power Handling vs. Frequency

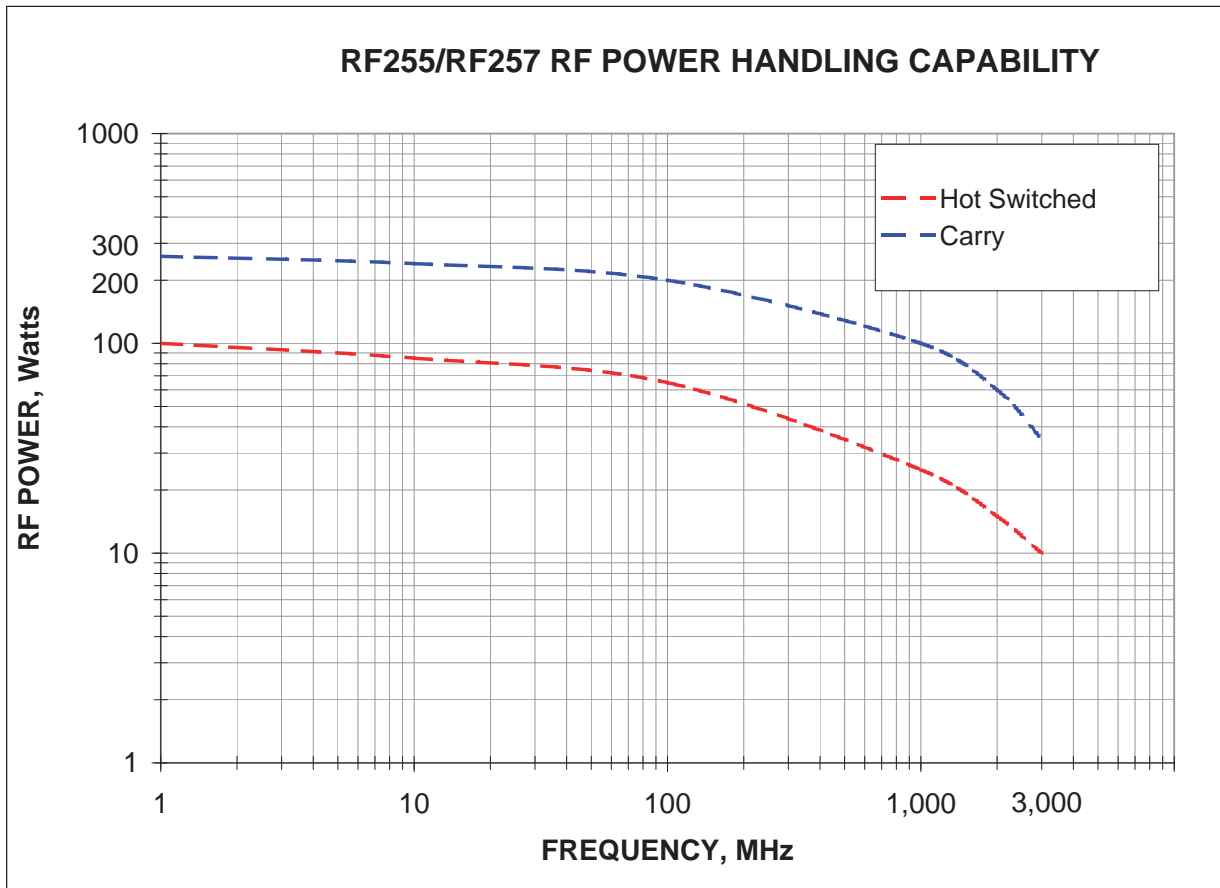

Test Notes:
 1. Test condition: Ambient temperature and pressure.
 2. Hot switched cycle rate: 1/3 Hz.
 3. Matched load: 1.2:1 maximum

Contact Load and Life Ratings		
LOAD LEVEL	CONTACT LOAD	CONTACT LIFE
Low level/Mechanical	10-50µA at 10-50 mVdc or Peak AC	100,000 cycles rated life
		1,000,000 cycles unmonitored (Mechanical Life)
Intermediate Current	100mA at 28Vdc	50,000 cycles
High Level, Resistive	2.0A at 28Vdc	100,000 cycles
High Level, Inductive	750 mA at 28Vdc, with 0.20H inductance	100,000 cycles
High Level, Lamp	160mA at 28Vdc	100,000 cycles
Overload, Resistive	4.0A at 28Vdc	100 cycles
Specifications based on relay case being grounded, unless otherwise specified		

Static Contact Resistance or Voltage Drop		
Measurement Condition		Maximum Static Contact Resistance or Voltage Drop
Initial		0.050Ω
Low Level Life	During test	33Ω (1.65mVdc monitoring Level)
	After 100,000 or 1,000,000 cycle life	0.150Ω
Intermediate Current	During test	3Ω (100mVdc monitoring Level)
	After 50,000	0.100Ω
High Level Life	During life	Voltage drop no more than 5% of open circuit voltage (1.4 Vdc monitoring level)
	After 100,000 cycle life	0.100Ω.
Overload	During test	Not Monitored
	After 100 cycle life	0.100Ω

General Electrical Specifications	
Insulation Resistance	1,000 MΩ minimum at 500Vdc
	500MΩ minimum at 500Vdc between coil and case at +125°C
	500MΩ minimum at 500Vdc after 100 cycle overload
	100,000 cycle high life, or 50,000 intermediate current tests
Dielectric Strength	500Vrms ±5% at 50 or 60Hz
	375Vrms at 50 or 60Hz after 100 cycle overload, 100,000 cycle high level life, or 50,000 intermediate current tests
Operate Time	3.0 ms maximum with rated coil voltage
Bounce Time	4.0 ms maximum with rated coil voltage

Coil Data and Operating Characteristics of Basic Relays						
Coil Voltage (Vdc)		Room Ambient Temperature (+25°C)			Over Temperature Range	
Rated	Max	Coil Resistance (Ω) ±10%	Latch/Reset Voltage (Vdc)		Latch/Reset Voltage (Vdc)	
			Max	Min	Max	Min
5.0	6.7	45	2.7	1.6	3.8	1.0
6.0	8.0	63	3.25	2.0	4.5	1.3
12.0	16.0	254	6.5	4.0	9.0	2.6
26.5	32.0	1000	13.0	8.0	18.0	5.2
48.0	64.0	3800	26.0	16.0	36.0	10.4

Test/Inspection Flow

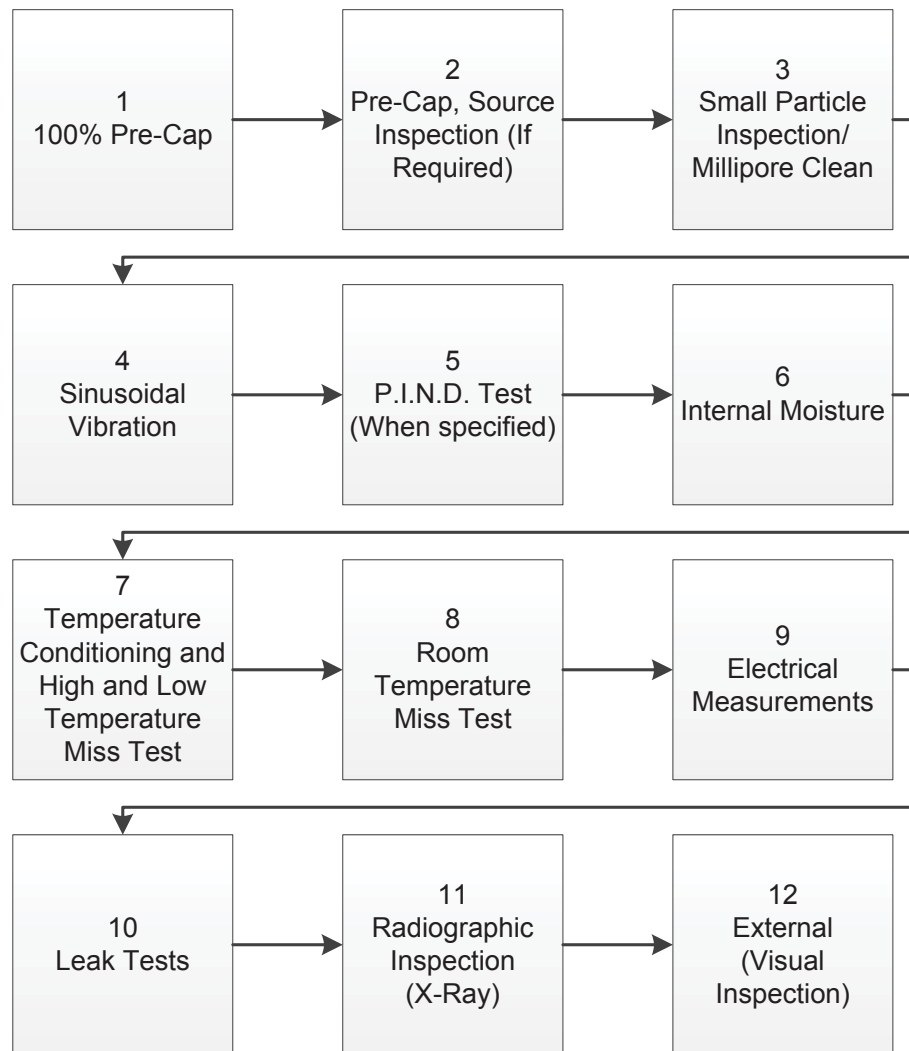

DETAILED SUMMARY OF STANDARD SCREENING	
100% Pre-Cap Inspection	Relays shall be examined to verify workmanship and cleanliness of the contact systems and motor mechanisms. Customer source inspection may be performed.
100% Small Particle Inspection (Millipore Clean)	In process inspection to further evaluate relay cleanliness by quality control inspectors prior to seal.
Room Temperature Electrical Measurements	
Coil Resistance	Relay coils shall be tested in accordance with MIL-STD-202, method 203. Limit of error of measuring apparatus: $\pm 2.5\%$
Insulation Resistance	The insulation resistance shall be 1,000 M Ω or more, unless otherwise specified. After the overload, high level life, and intermediate current tests, the insulation resistance shall be 500 M Ω or more.
Dielectric Withstanding Voltage (Atmospheric Pressure)	Relays shall withstand the test voltage specified without damage, and there shall be no leakage current in excess of 100 μ A r.m.s. nor external evidence of damage due to arcing (air discharge), flash over (surface discharge), or insulation breakdown (puncture discharge). After the overload, high level life, and intermediate current tests, the dielectric withstanding voltage shall be at least 75 % of the allowable initial atmospheric value.
Static Contact Resistance	The static contact resistance shall not exceed 0.50 Ω .
Operating Characteristics	Latch/Reset voltage as specified on page 5
Operate and Release Time	The operate time shall be as specified on page 4. For double-throw contacts, there shall be no closing of open contacts before all closed contacts have opened. This applies to either state of the relay.
Dynamic Contact Resistance	Contact bounce time as specified on page 5 Contact stabilization time: The time to reach and maintain a static contact resistance state shall not exceed 3.0 ms, when specified. After overload, high level life, and intermediate current tests, contact bounce time shall be measured in lieu of contact stabilization time.
Solderability	
Relays shall be tested in accordance with MIL-STD-202, method 208.	Any termination that has less than 5 % of the total solder coated area (except the area within 0.050 in. from the emergence from the seating plane) dewetted, nonwetted, or with pinholes is acceptable. Other anomalies shall not be cause for rejection.
Seal	
When tested as specified in 4.11.5, there shall be no leakage in excess of 1×10^{-8} atm-cm ³ /s of air.	Relays sealed with a tracer gas shall be tested in accordance with MIL-STD-202, method 112.
Visual Inspection (External)	Relays shall be uniform in quality, and be free from cracked and displaced parts, sharp edges, burrs and other defects that will affect life and serviceability

DETAILED SUMMARY OF STANDARD SCREENING

Sinusoidal Vibration	Relays shall be tested in accordance with MIL-STD-202, method 204. The following details and exceptions shall apply: Mounting method: Rigidly mounted by normal mounting means. Test condition D, except vibration level is the lesser of 0.195 inch double amplitude or 30 G peak, unless otherwise specified (see 3.1) and the frequency range shall be 10 Hz to 2,500 Hz. Contacts monitored to detect contact chatter and transfer.
Random Vibration (If Specified)	Relays shall be tested in accordance with MIL-STD-202, method 214. The following details and exceptions shall apply: Mounting method: Rigidly mounted by normal mounting means. Test condition: Table I, test condition G (0.4 G ² /Hz, 23.9 G r.m.s.). Contacts monitored to detect contact chatter and transfer.
Particle Impact Noise Detection (PIND)	Each relay shall be subjected to a PIND test capable of detecting the presence of loose particles within the relay enclosure in accordance with the requirements of Teledyne Relays' Procedure 0-40-824, which must be approved by the Orderer. Relays so tested shall exhibit no evidence of loose particle contamination.
Internal Moisture	Relays (coils de-energized) shall be at ambient room temperature prior to the start of test. The insulation resistance of all contact pins to case only shall be measured and observed. The relay coil shall be energized with 140 % of rated voltage for a period of 2½ minutes. For latching relays, this test shall be repeated for each coil. The insulation resistance of all contact pins to case only shall be verified a minimum of once each 30 seconds during this period.
Thermal Cycle	Each relay shall be subjected to 5 cycles of thermal shock in accordance with MIL-STD-202, Method 107, Test Condition B at the minimum and maximum rated temperatures (see 3.1). The following details and exceptions apply: The relay shall be de-energized during the first four temperature conditioning cycles, and the coil continuity shall be monitored continuously during this time. Monitoring current shall not exceed 300 MA. The relay shall be de-energized during low temperature. Step one of each temperature cycle shall be high temperature; step 3 of each temperature cycle shall be low temperature. At the end of each temperature extreme during the fifth temperature cycle (Steps 1 and 3), each relay shall be tested as follows: Latching relays shall be energized with the set and the reset coil alternately energized with maximum rated voltage for a minimum of ½ hour each. At the end of this time and while still at the high temperature extreme, perform the following electrical measurements: insulation resistance (at high temperature only), static contact resistance, operating characteristics, operate and release time and contact bounce time. Following the electrical measurements, perform the miss test. During Step 4 of the fifth cycle, stabilize the relays at room ambient for a minimum of 1 hour, with the coil(s) de-energized.
Miss Test (Run-in)	Relays shall be subjected to a 2,500 cycle run-in test at each of the applicable ambient temperatures. The following details apply: Coil energization conditions: The coil(s) shall be energized and cycled at maximum rated voltage (see 3.1). Cycling Rate: 1 to 5 Hz. Contact loading: Relays shall have the contacts loaded as follows: open circuit load voltage 10 to 50 mV d.c. or peak a.c., load current 10 to 50 µA Monitoring: The contact voltage drop or resistance for each pair of mated contacts shall be monitored during 40 % minimum of each "on" and each "off" period, within the latter 50 % of each period. The test equipment shall record all relay failures

DETAILED SUMMARY OF STANDARD SCREENING	
Miss Test (cont'd)	Number of misses allowed: None. Applicable Ambient Temperature: Ambient High Temperature +125 ° C Ambient Low Temperature - 65 ° C Ambient Room Temperature +25 ° C
Radiographic Inspection (X-Ray)	Each relay shall be examined to determine proper internal construction in accordance with the requirements of Teledyne Relays' Procedure 0-40-193, which must be approved by the Orderer.
Percent Defect Allowable	
Check for failure lot rate (Must be less than 10%)	

Lot Acceptance Tests Level 2

Customer has a choice of any combination of the groups below

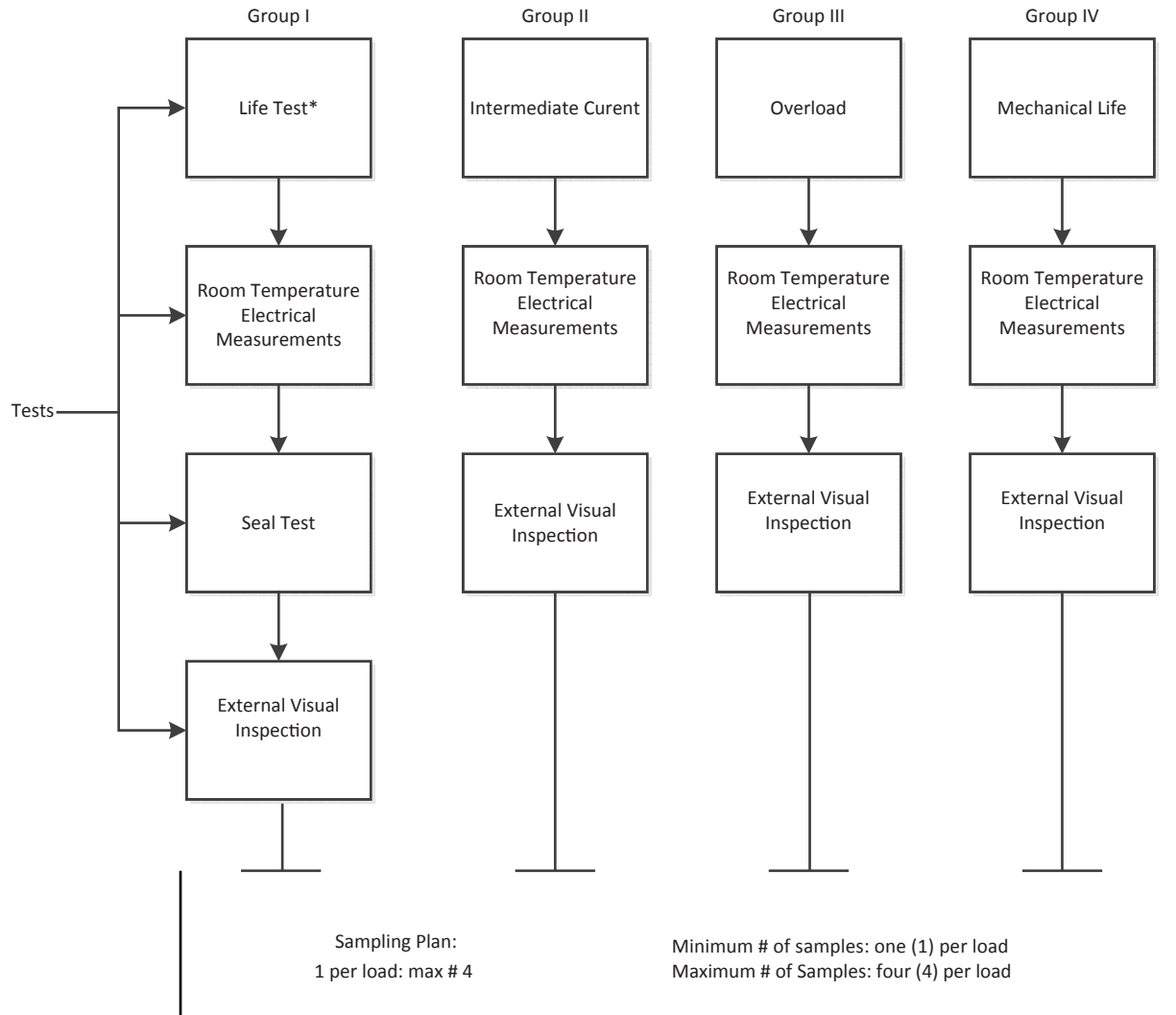

Acceptance Criteria → No Failures Allowed

Legend:

- Loads offered: 2
 - dc Resistive: Amp, 28 Vdc, 100,000 cycles, 20± 2 cpm, 125°C
 - dc Inductive: 750 MA, 28 Vdc, 100,00 cycles, 10± 1 cpm, 0.20 H inductanca, 125°C
 - Lamp Load: 160 MA, 28 Vdc, 100,000 cycles
 - Low Level Life: 10-50 microamps, 10-50 millivolts, 100,000 cycles (monitored), 125°C
- Intermediate Current: 100 mA, 28 Vdc, 50,000 cycles, 10± 1 cpm, , 125°C
- Overload: 4 Amp, 28 Vdc, 100 cycles, 20± 2 cpm, 125°C
- Mechanical life: 10-50 microamps, 10-50 millivolts, 1,000,000 cycles (unmonitored), room ambient temperature

GLOSSARY

Coil

A wire assembly wound around an insulating bobbin or spool.

Contact arrangement

The combination of contacts that make up the entire relay switching structure.

Contact bounce

Internally caused intermittent and undesired opening of closed contacts, or closing of open contacts.

Contact bounce time

The interval between first make of the contact until the uncontrolled opening and closing of the contact ceases.

Contact chatter

The momentary opening of a closed contact due to external shock or vibration.

Contact force

The force exerted by a movable contact against its matching stationary contact when the contacts are closed.

Contact gap

The minimum distance between a moving contact and its matching stationary contact when the contacts are open.

Contact Stabilization Time

The interval between the first closure of a contact until the contacts reach and maintain a static contact resistance state.

Contact weld

The fusing of contacts, resulting in their failure to open.
Contacts The current-carrying parts of a relay that open or close electrical circuits.

Cycle, relay

One opening and one closure of a contact set. One cycle consists of two operations.

Dropout voltage, specified

As the voltage on an energized relay is decreased, the voltage at or above which all relay contacts must return to their deenergized positions. Not applicable to latching relays.

Electromechanical relay

A relay in which the motion of the contacts are dependent upon the magnetic attraction or repulsion of an armature to or from a pole face. The magnetic force is generated by a coil which may or may not incorporate suppression and/or polarity reversal protection methods.

Hermetically sealed relay

A relay contained within an enclosure that is sealed by welding to insure a low rate of gas leakage.

Inspection lot

A grouping of relays based upon their similarity in manufacturing process characteristics and screening requirements submitted for inspection at one time.

Latching (bistable) relay

A two-position relay whose contacts transfer only as a result of coil energization of a particular coil, remain in that position with no coil energization, and transfer to the alternate position only as a result of coil energization of the other coil.

Miss

Failure to establish the intended contact conditions.

Neutral position

An anomalous state in latching (bistable) relays normally produced by insufficient coil signal or simultaneous pulsing of set and reset coils. Analogous to “don’t care” condition in electronic latches. This condition is not harmful to the relay.

Normal mounting means

A method of mounting whereby an intended test is performed on a relay and the fixture(s) employed adequately supports the relay and neither attenuates nor amplifies the intended condition.

Normally closed contact

Those contacts that are closed with the relay de-energized. Not applicable to latching relays.

Normally open contact

Those contacts that are open with the relay de-energized. Not applicable to latching relays.

Operate time

The interval between the application of an input signal and first closing of a normally open contact. Bounce time is not included.

Operation, relay

One opening or closure of a contact set. One relay operation is one-half of a cycle.

GLOSSARY

Output

The circuit within a relay which controls an external load circuit and is changed from a conducting to a non-conducting state (and vice versa) by the relay operation.

Pickup voltage, specified

As the current or voltage on a de-energized relay is increased, the voltage at or below which all contacts must achieve their energized positions.

Polarized relay

A relay, the operation of which is primarily dependent upon the direction (polarity) of the energizing current(s) and the resultant magnetic flux.

Production lot

A grouping of relays released for production as a single lot.

Rated coil voltage

The coil voltage at which the relay is designed to operate and meet all specified electrical, mechanical and environmental requirements.

Relay

An electrically controlled switch.

Release time

The interval between the removal of an input signal and first closing of a normally closed contact. Bounce time is not included. Not applicable to latching relays.

Reset Voltage

The voltage required to return the contacts of a latching relay from a set position to a specified initial condition. There is no universally defined reset position.

Saturation

The condition attained in a magnetic material when an increase in magnetizing (coil) current produces no appreciable increase in flux.

Set Voltage

The voltage required to change the contact position of a latching relay from a specified initial condition. There is no universally defined set position.

Supply voltage

The voltage source that supplies power to drive the relay coil.