

PART NUMBER	DESCRIPTION
CCT-49K	Commercial Latching Multi-throw, DC-40 GHz
CT-49K	Elite Latching Multi-throw, DC-40GHz

The CCT-49K/CT-49K is an Internally Terminated broadband, multi-throw, electromechanical coaxial switch designed to switch a microwave signal from a common input to any of 3, 4, 5, or 6 outputs. The characteristic impedance is 50 Ohms. Internal terminations provide an impedance match for the unselected ports. The switches are small using the popular connector spacing on a 1.062" dia. circle. Each position has an individual actuator mechanism allowing random position selection. This also minimizes switching time.

The CCT-49K/CT-49K comes with a latching actuator. The latching switch remains in the last position selected when the switch is de-energized. STD dual command requires a reset pulse before a new selected position. A separate reset circuit allows all positions to be set to an open position. User must provide both reset (clear) and set (select new position) commands.



ENVIRONMENTAL AND PHYSICAL CHARACTERISTICS	
Operating Temperature	
Commercial Model, CCT-49K	-40°C to 65°C
Elite Model, CT-49K	-55°C to 85°C
Vibration (MIL-STD-202 Method 214, Condition D, non-operating)	10 g's RMS
Shock (MIL-STD-202 Method 213, Condition D, non-operating)	500 g's
Standard Actuator Life	5,000,000 cycles
Actuator Life w/ Additional Features	1,000,000 cycles
Connector Type	2.92mm (K)
Humidity (Moisture Seal)	Available
Weight	6 oz. (170.1g) (max.)

ELECTRICAL CHARACTERISTICS	
Form Factor	Multi-Throw, break before make
Frequency Range	
CCT-49K	DC-40 GHz
CT-49K	DC-40 GHz
Characteristic Impedance	50 Ohms
Operate Time	20 ms (max.)
Terminations	50Ω
Actuation Voltage Available	12 15 24 28 V
Actuation Current	255 205 130 90 mA
Reset Current (# of Positions)	3 765 615 390 270 mA
	4 1020 820 520 360 mA
	5 1275 1025 650 450 mA
	6 1530 1230 780 540 mA

PERFORMANCE CHARACTERISTICS					
Frequency	DC-12 GHz	12-18 GHz	18-28 GHz	28-36 GHz	36-40 GHz
Insertion Loss, dB, max.	0.2	0.4	0.5	1.0	1.4
Isolation, dB, min.	75	70	70	60	60
VSWR, max.	1.25:1	1.50:1	1.5:1	1.80:1	2.10:1

For maximum limits, please see charts on pages 6-8

PART NUMBERING SYSTEM

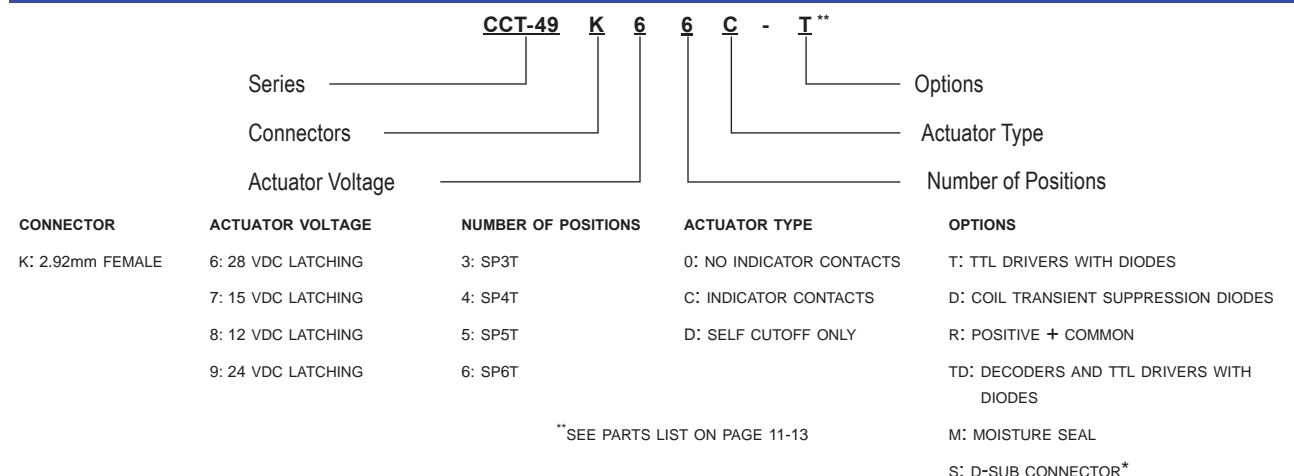

For additional options, please contact factory.

* D-Sub Connector may be 9 or 15 pin depending on number of throws. (See Connector Pinout page)

Series CCT-49K/CT-49K

Internal 50Ω Termination DC-40 GHz
Latching Multi-Throw Coaxial Switch



SCHEMATICS AND MECHANICAL OUTLINE

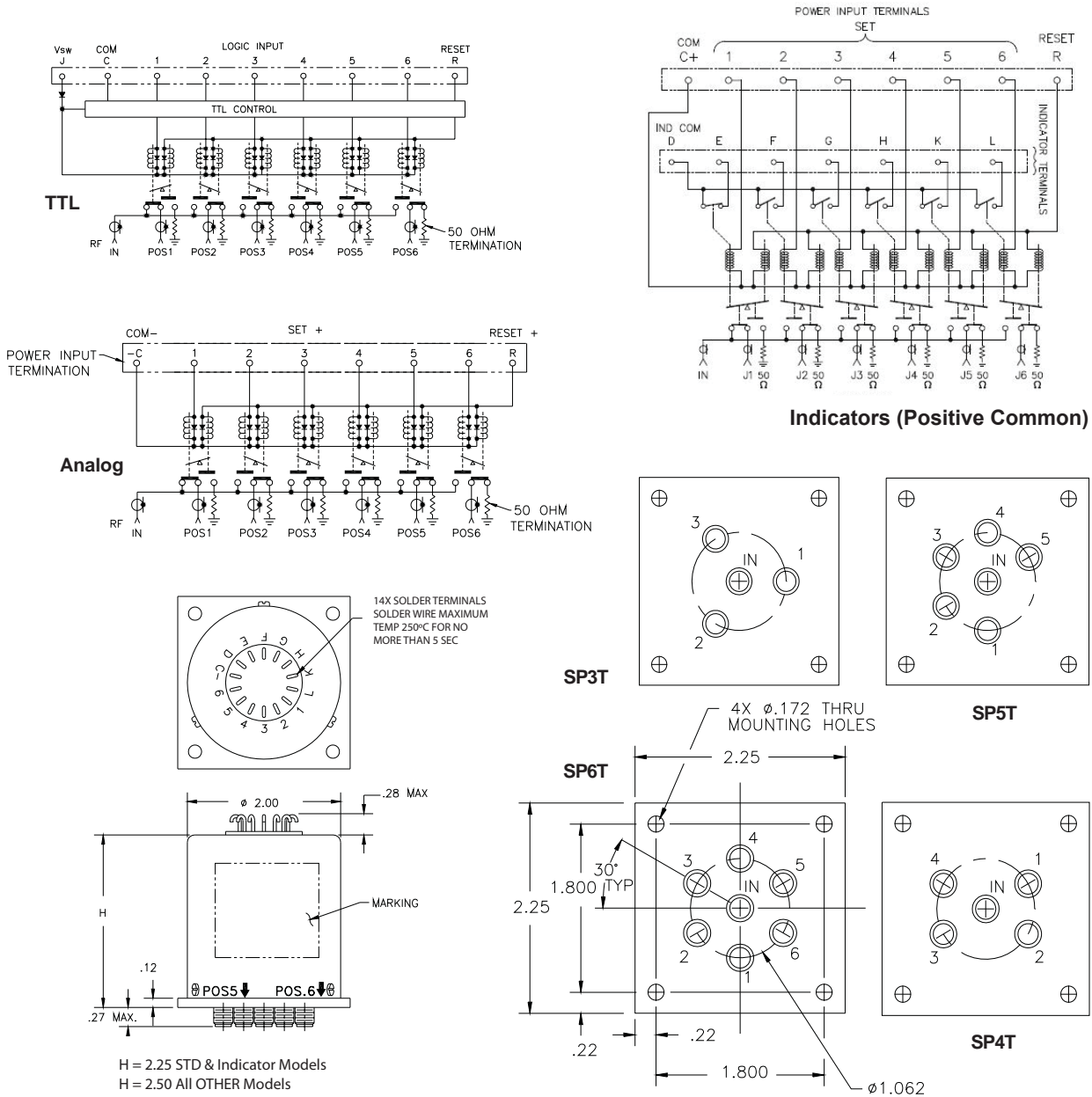

“-S OPTION” 9-PIN, 15-PIN, 26-PIN D-SUB CONNECTOR (EXAMPLE: CCT-49Ks660-S)

CONNECTOR PINOUT FOR LATCHING SP3T MULTI-THROW SWITCHES						
EXAMPLE	CT-49K630-S	CT49K63C-S	CT49K630-TS	CT49K63C-TS	CT49K630-TDS	CT49K63C-TDS
INDICATOR		Yes		Yes		Yes
TTL			Yes	Yes		
DECODERS & TTL					Yes	Yes
PIN NO.	9-PIN	15-PIN	9-PIN	15-PIN	9-PIN	15-PIN
1	PORT 1	PORT 1	TTL 1	TTL 1	LOGIC 1	LOGIC 1
2	PORT 2	PORT 2	TTL 2	TTL 2	LOGIC 2	LOGIC 2
3	PORT 3	PORT 3	TTL 3	TTL 3	LOGIC 3	LOGIC 3
4						
5						
6						
7	COMMON	COMMON	COMMON	COMMON	COMMON	COMMON
8	RESET	RESET	RESET	RESET		
9			VSW	VSW	VSW	VSW
10		D INDICATOR (COM)		D INDICATOR (COM)		D INDICATOR (COM)
11		E INDICATOR		E INDICATOR		E INDICATOR
12		F INDICATOR		F INDICATOR		F INDICATOR
13		G INDICATOR		G INDICATOR		G INDICATOR
14						
15						

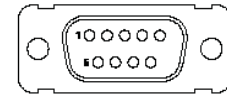

9-PIN D-SUB CONNECTOR

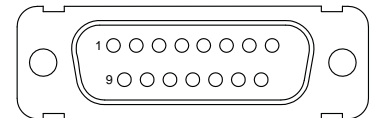

15-PIN D-SUB CONNECTOR

CONNECTOR PINOUT FOR LATCHING SP4T MULTI-THROW SWITCHES						
EXAMPLE	CT-49K640-S	CT49K64C-S	CT49K640-TS	CT49K64C-TS	CT49K640-TDS	CT49K64C-TDS
INDICATOR		Yes		Yes		Yes
TTL			Yes	Yes		
DECODERS & TTL					Yes	Yes
PIN NO.	9-PIN	15-PIN	9-PIN	15-PIN	9-PIN	15-PIN
1	PORT 1	PORT 1	TTL 1	TTL 1	LOGIC 1	LOGIC 1
2	PORT 2	PORT 2	TTL 2	TTL 2	LOGIC 2	LOGIC 2
3	PORT 3	PORT 3	TTL 3	TTL 3	LOGIC 3	LOGIC 3
4	PORT 4	PORT 4	TTL 4	TTL 4		
5						
6						
7	COMMON	COMMON	COMMON	COMMON	COMMON	COMMON
8	RESET	RESET	RESET	RESET		
9			VSW	VSW	VSW	VSW
10		D INDICATOR (COM)		D INDICATOR (COM)		D INDICATOR (COM)
11		E INDICATOR		E INDICATOR		E INDICATOR
12		F INDICATOR		F INDICATOR		F INDICATOR
13		G INDICATOR		G INDICATOR		G INDICATOR
14		H INDICATOR		H INDICATOR		H INDICATOR
15						

CONNECTOR PINOUT FOR LATCHING SP5T MULTI-THROW SWITCHES						
EXAMPLE	CT-49K650-S	CT49K65C-S	CT49K650-TS	CT49K65C-TS	CT49K650-TDS	CT49K65C-TDS
INDICATOR		Yes		Yes		Yes
TTL			Yes	Yes		
DECODERS & TTL					Yes	Yes
PIN NO.	9-PIN	15-PIN	9-PIN	15-PIN	9-PIN	15-PIN
1	PORT 1	PORT 1	TTL 1	TTL 1	LOGIC 1	LOGIC 1
2	PORT 2	PORT 2	TTL 2	TTL 2	LOGIC 2	LOGIC 2
3	PORT 3	PORT 3	TTL 3	TTL 3	LOGIC 3	LOGIC 3
4	PORT 4	PORT 4	TTL 4	TTL 4		
5	PORT 5	PORT 5	TTL 5	TTL 5		
6						
7	COMMON	COMMON	COMMON	COMMON	COMMON	COMMON
8	RESET	RESET	RESET	RESET		
9			VSW	VSW	VSW	VSW
10		D INDICATOR (COM)		D INDICATOR (COM)		D INDICATOR (COM)
11		E INDICATOR		E INDICATOR		E INDICATOR
12		F INDICATOR		F INDICATOR		F INDICATOR
13		G INDICATOR		G INDICATOR		G INDICATOR
14		H INDICATOR		H INDICATOR		H INDICATOR
15		K INDICATOR		K INDICATOR		K INDICATOR

Series CCT-49K/CT-49K
 Internal 50Ω Termination DC-40 GHz
 Latching Multi-Throw Coaxial Switch



CONNECTOR PINOUT FOR LATCHING SP6T MULTI-THROW SWITCHES						
EXAMPLE	CT-49K660-S	CT49K66C-S	CT49K660-TS	CT49K66C-TS	CT49K660-TDS	CT49K66C-TDS
INDICATOR		YES		YES		YES
TTL			YES	YES		YES
DECODERS & TTL					YES	YES
PIN NO.	9-PIN	15-PIN	9-PIN	15-PIN	9-PIN	15-PIN
1	PORT 1	PORT 1	TTL 1	TTL 1	LOGIC 1	LOGIC 1
2	PORT 2	PORT 2	TTL 2	TTL 2	LOGIC 2	LOGIC 2
3	PORT 3	PORT 3	TTL 3	TTL 3	LOGIC 3	LOGIC 3
4	PORT 4	PORT 4	TTL 4	TTL 4		
5	PORT 5	PORT 5	TTL 5	TTL 5		VSW
6	PORT 6	PORT 6	TTL 6	TTL 6		
7	COMMON	COMMON	COMMON	COMMON	COMMON	COMMON
8	RESET	RESET	RESET	RESET		
9		D INDICATOR (COM)	VSW	VSW	VSW	D INDICATOR (COM)
10		E INDICATOR				E INDICATOR
11		F INDICATOR				F INDICATOR
12		G INDICATOR				G INDICATOR
13		H INDICATOR				H INDICATOR
14		K INDICATOR				K INDICATOR
15		L INDICATOR				L INDICATOR
16				D INDICATOR (COM)		
17				E INDICATOR		
18				F INDICATOR		
19				G INDICATOR		
20				H INDICATOR		
21				K INDICATOR		
22				L INDICATOR		
23						
24						
25						
26						

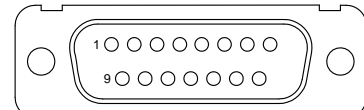

15-PIN D-SUB CONNECTOR

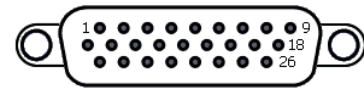

26-PIN D-SUB CONNECTOR

TRUTH TABLE Latching
CCT-49KX3C-T

Logic Input				RF Path				Indicator Switches		
1	2	3	R	J1	J2	J3	Reset	E	F	G
1	0	0	0	On	Off	Off	Off	C	0	0
0	1	0	0	Off	On	Off	Off	0	C	0
0	0	1	0	Off	Off	On	Off	0	0	C

TRUTH TABLE Latching
CCT-49KX3C-TD

Logic Input			RF Path				Indicator Switches		
1	2	3	J1	J2	J3	Reset	E	F	G
0	0	0	On	Off	Off	Off	C	0	0
1	0	0	Off	On	Off	Off	0	C	0
0	1	0	Off	Off	On	Off	0	0	C
0	1	1	Off	Off	Off	Reset	0	0	0
1	1	1	COIL OFF				0	0	0

TRUTH TABLE Latching
CCT-49KX4C-T

Logic Input					RF Path					Indicator Switches			
1	2	3	4	R	J1	J2	J3	J4	Reset	E	F	G	H
1	0	0	0	0	On	Off	Off	Off	Off	C	0	0	0
0	1	0	0	0	Off	On	Off	Off	Off	0	C	0	0
0	0	1	0	0	Off	Off	On	Off	Off	0	0	C	0
0	0	0	1	0	Off	Off	Off	On	Off	0	0	0	C

TRUTH TABLE Latching
CCT-49KX4C-TD

Logic Input			RF Path					Indicator Switches			
1	2	3	J1	J2	J3	J4	Reset	E	F	G	H
0	0	0	On	Off	Off	Off	Off	C	0	0	0
1	0	0	Off	On	Off	Off	Off	0	C	0	0
0	1	0	Off	Off	On	Off	Off	0	0	C	0
1	1	0	Off	Off	Off	On	Off	0	0	0	C
0	1	1	Off	Off	Off	Off	Reset	0	0	0	0
1	1	1	COIL OFF					0	0	0	0

Series CCT-49K/CT-49K

Internal 50Ω Termination DC-40 GHz
Latching Multi-Throw Coaxial Switch



TRUTH TABLE Latching CCT-49KX5C-T

Logic Input						RF Path						Indicator Switches				
1	2	3	4	5	R	J1	J2	J3	J4	J5	Reset	E	F	G	H	K
1	0	0	0	0	0	On	Off	Off	Off	Off	Off	C	0	0	0	0
0	1	0	0	0	0	Off	On	Off	Off	Off	Off	0	C	0	0	0
0	0	1	0	0	0	Off	Off	On	Off	Off	Off	0	0	C	0	0
0	0	0	1	0	0	Off	Off	Off	On	Off	Off	0	0	0	C	0
0	0	0	0	1	0	Off	Off	Off	Off	On	Off	0	0	0	0	C

TRUTH TABLE Latching CCT-49KX5C-TD

Logic Input			RF Path					Indicator Switches					
1	2	3	J1	J2	J3	J4	J5	Reset	E	F	G	H	K
0	0	0	On	Off	Off	Off	Off	Off	C	0	0	0	0
1	0	0	Off	On	Off	Off	Off	Off	0	C	0	0	0
0	1	0	Off	Off	On	Off	Off	Off	0	0	C	0	0
1	1	0	Off	Off	Off	On	Off	Off	0	0	0	C	0
0	0	1	Off	Off	Off	Off	On	Off	0	0	0	0	C
0	1	1	Off	Off	Off	Off	Off	Reset	0	0	0	0	0
1	1	1	COIL OFF						0	0	0	0	0

TRUTH TABLE Latching CCT-49KX6C-T

Logic Input							RF Path							Indicator Switches					
1	2	3	4	5	6	R	J1	J2	J3	J4	J5	J6	Reset	E	F	G	H	K	L
1	0	0	0	0	0	0	On	Off	Off	Off	Off	Off	Off	C	0	0	0	0	0
0	1	0	0	0	0	0	Off	On	Off	Off	Off	Off	Off	0	C	0	0	0	0
0	0	1	0	0	0	0	Off	Off	On	Off	Off	Off	Off	0	0	C	0	0	0
0	0	0	1	0	0	0	Off	Off	Off	On	Off	Off	Off	0	0	0	C	0	0
0	0	0	0	1	0	0	Off	Off	Off	Off	On	Off	Off	0	0	0	0	C	0
0	0	0	0	0	1	0	Off	Off	Off	Off	Off	On	Off	0	0	0	0	0	C

TRUTH TABLE Latching CCT-49KX6C-TD

Logic Input			RF Path						Indicator Switches						
1	2	3	J1	J2	J3	J4	J5	J6	Reset	E	F	G	H	K	L
0	0	0	On	Off	Off	Off	Off	Off	Off	C	0	0	0	0	0
1	0	0	Off	On	Off	Off	Off	Off	Off	0	C	0	0	0	0
0	1	0	Off	Off	On	Off	Off	Off	Off	0	0	C	0	0	0
1	1	0	Off	Off	Off	On	Off	Off	Off	0	0	0	C	0	0
0	0	1	Off	Off	Off	Off	On	Off	Off	0	0	0	0	C	0
1	0	1	Off	Off	Off	Off	Off	On	Off	0	0	0	0	0	C
0	1	1	Off	Off	Off	Off	Off	Off	Reset	0	0	0	0	0	0
1	1	1	COIL OFF							0	0	0	0	0	0

TYPICAL RF PERFORMANCE CURVES

INSERTION LOSS

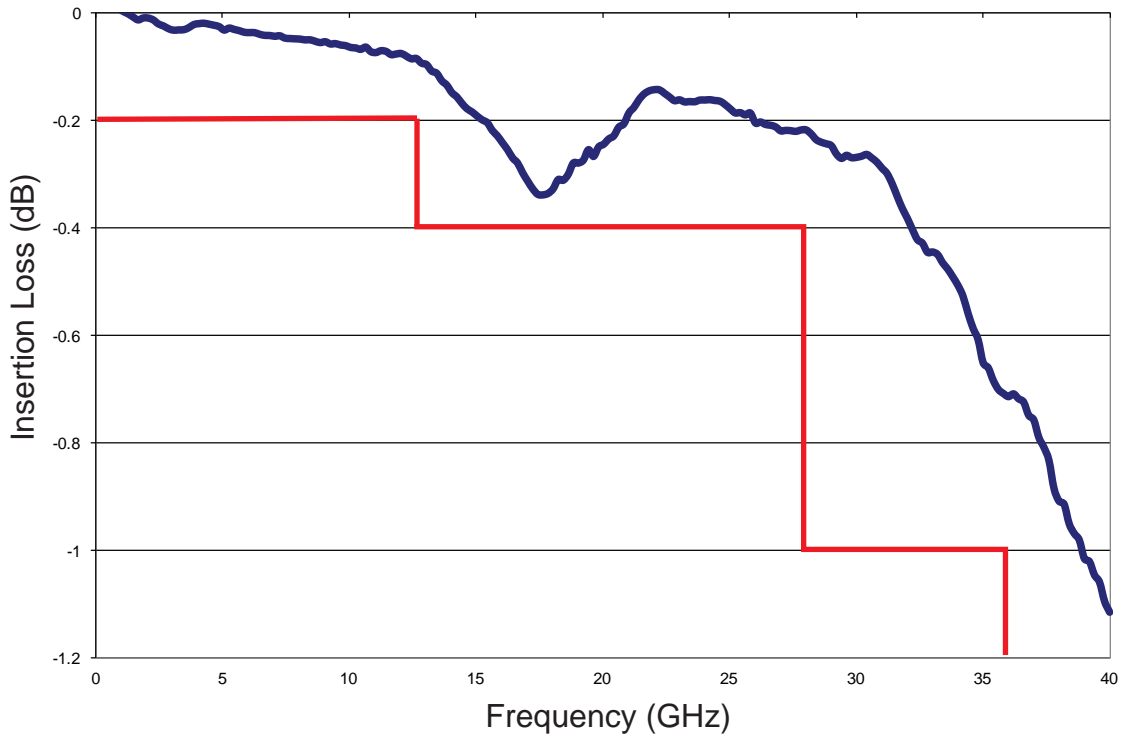

VSWR

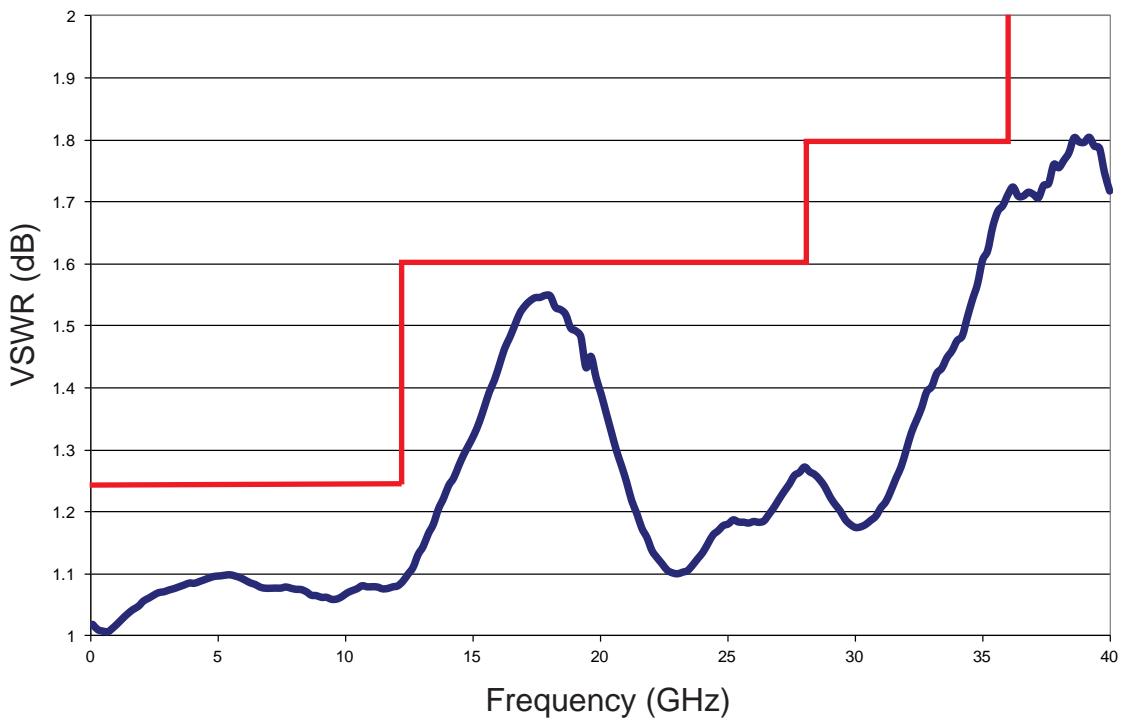

TYPICAL RF PERFORMANCE CURVES

ISOLATION

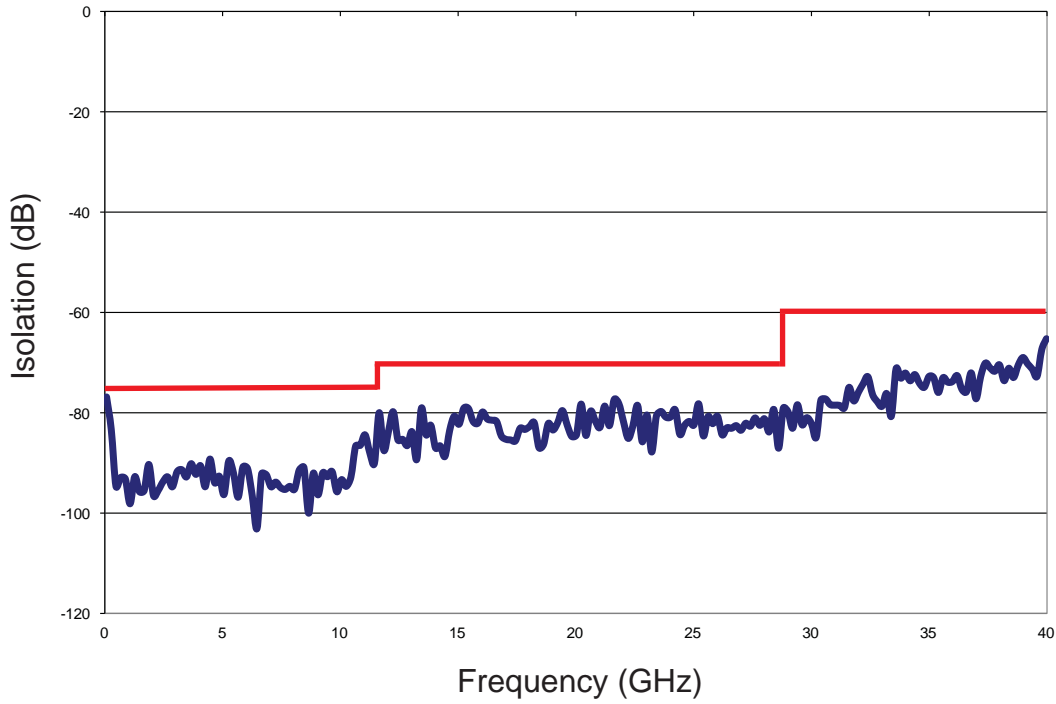

TYPICAL POWER PERFORMANCE CURVE

Power Handling vs. Frequency

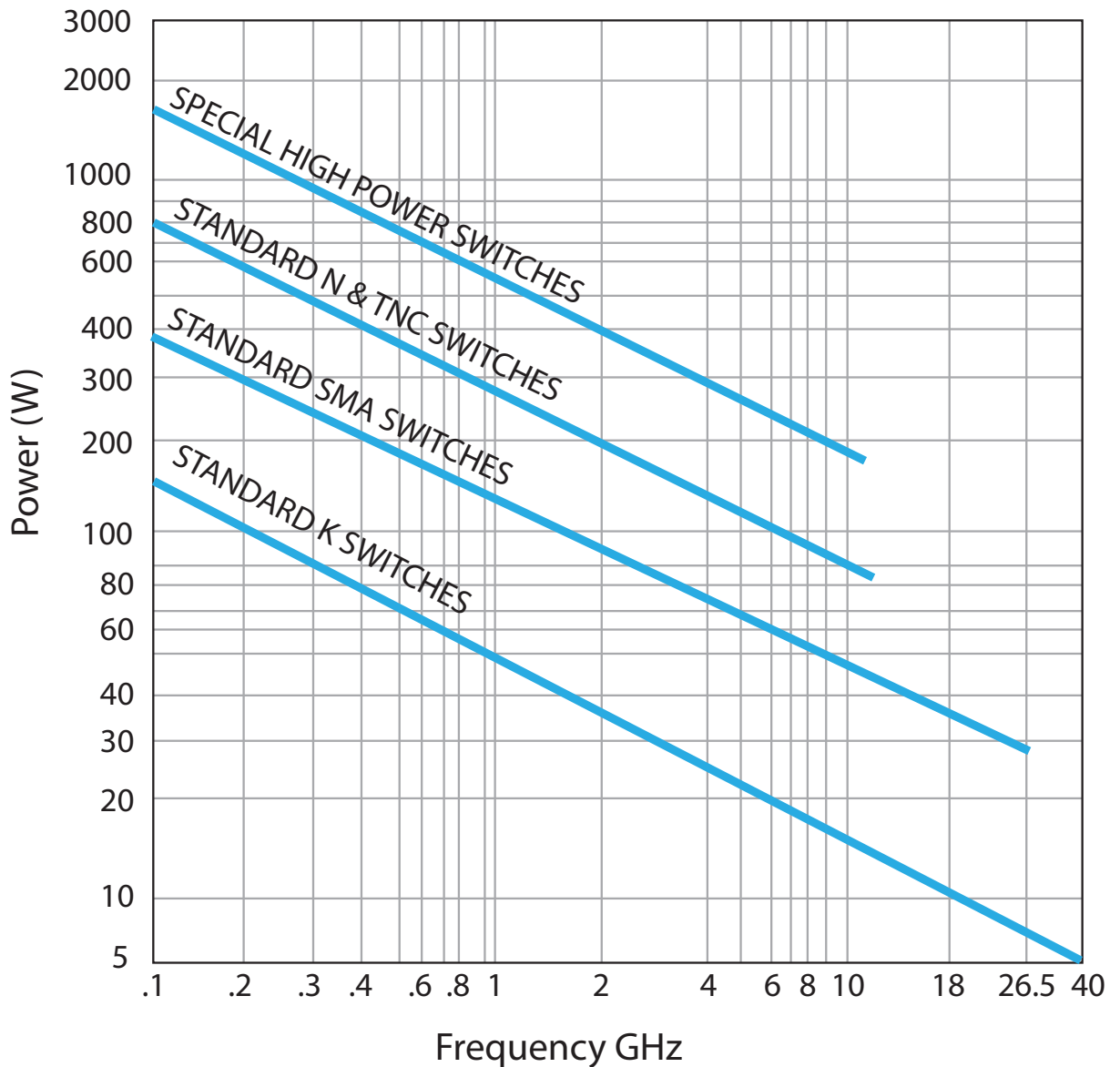

Estimates based on the following reference conditions:

- Ambient temperature of 40°C or less
- Sea level operation
- Load VSWR of 1.20:1 maximum
- No high-power (hot) switching

Please contact Teledyne Coax Switches for derating factors when applications do not meet the foregoing reference conditions.

GLOSSARY

Actuator

An actuator is the electromechanical mechanism that transfers the RF contacts from one position to another upon DC command.

Arc Suppression Diode

A diode is connected in parallel with the coil. This diode limits the "reverse EMF spike" generated when the coil de-energizes to 0.7 volts. The diode cathode is connected to the positive side of the coil and the anode is connected to the negative side.

Date Code

All switches are marked with either a unique serial number or a date code. Date codes are in accordance with MIL-STD-1285 Paragraph 5.2.5 and consist of four digits. The first two digits define the year and the last two digits define the week of the year (YYWW). Thus, 1032 identifies switches that passed through final inspection during the 32nd week of 2010.

Indicator

Indicators tell the system which position the switch is in. Other names for indicators are telemetry contacts or tellback circuit. Indicators are usually a set of internally mounted DC contacts linked to the actuator. They can be wired to digital input lines, status lights, or interlocks. Unless otherwise specified, the maximum indicator contact rating is 30 Vdc, 50 mA, or 1.5 Watts into a resistive load.

Isolation

Isolation is the measure of the power level at the output connector of an unconnected RF channel as referenced to the power at the input connector. It is specified in dB below the input power level.

Multi-Throw Latching Switch

A multi-throw switch is a switch with one input and three or more output ports. The CCT-49K can switch a microwave signal to any of 2,3,4,5 or 6 output from a single common input.

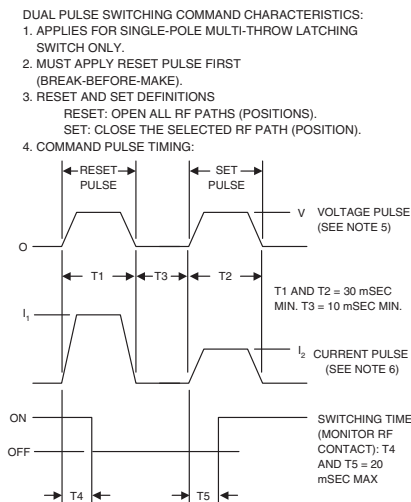

5. COMMAND SWITCHING VOLTAGE:
 V = 26-32 VDC PULSE

6. SWITCHING CURRENT:

SWITCHING CURRENT AT 28 VDC AND 20°C		
NO. OF POS.	RESET (I ₁)	SET (I ₂)
3 POS.	270 mA	90 mA
4 POS.	360 mA	90 mA
5 POS.	450 mA	90 mA
6 POS.	540 mA	90 mA

Switching Time

Switching time is the total interval beginning with the arrival of the leading edge of the command pulse at the switch DC input and ending with the completion of the switch transfer, including contact bounce. It consists of three parts: (1) inductive delay in the coil, (2) transfer time of the physical movement of the contacts, and (3) the bounce time of the RF contacts.

TTL Switch Driver Option

As a special option, switch drivers can be provided for both failsafe and latching switches, which are compatible with industry-standard low-power Schottky TTL circuits.

TD-Option

This option includes a decoder. The 3-bit parallel command is decoded to internally select the appropriate position. See the logic tables. The TD-Option increases the Vsw supply current demand by 50mA max at 28Vdc and +20°C.

Performance Parameters vs Frequency

Generally speaking, the RF performance of coaxial switches is frequency dependent. With increasing frequency, VSWR and insertion loss increase while isolation decreases. All data sheets specify these three parameters as "worst case" at the highest operating frequency. If the switch is to be used over a narrow frequency band, better performance can be achieved.

Actuator Current vs Temperature

The resistance of the actuator coil varies as a function of temperature. There is an inverse relationship between the operating temperature of the switch and the actuator drive current. For switches operating at 28 VDC, the approximate actuator drive current at temperature, T, can be calculated using the equation:

$$I_T = \frac{I_A}{[1 + .00385 (T-20)]}$$

Where:

I_T = Actuator current at temperature, T

I_A = Room temperature actuator current – see data sheet

T = Temperature of interest in °C

Magnetic Sensitivity

An electro-mechanical switch can be sensitive to ferrous materials and external magnetic fields. Neighboring ferrous materials should be permitted no closer than 0.5 inches and adjacent external magnetic fields should be limited to a flux density of less than 5 Gauss.